



| Topic: | Page | Topic: | Page |
|---|------|---|------|
| 1. Description | 1 | 10. Flow K-factor | 10 |
| 2. Specifications | 1 | 11. Total K-factor | 11 |
| 3. Installation | 2 | 12. Time Base | 12 |
| 4. Wiring | 4 | 13. Decimal point placement | 13 |
| 5. Battery Installation and Replacement | 4 | 14. Speed | 14 |
| 6. Operation | 5 | 15. Sensitivity | 15 |
| 7. Security Code | 6 | 16. Troubleshooting | 16 |
| 8. Totalizer operation | 7 | 17. Flow and Totalizer K-factor selection | 16 |
| 9. Automatic Calibration | 9 | 18. K-factor Charts | 17 |
| | | 19. Ordering Information | 20 |

1. Description

The Signet 8150 Flow Totalizer is a battery-powered instrument capable of providing uninterrupted flow and total volume information for 4 years and beyond. The unique features of the 8150 include:

- Easy setup and display selection with 4-button keypad
- User selectable security access to prevent unwanted programming changes.
- Displays flow rate from 0.001 to 9999 engineering units with an auto-ranging decimal point.
- Three totalizers, one permanent and two that are independently resettable.
- Displays elapsed time between operating periods.
- Integral mount and panel mount options
- 3.6 V Lithium batteries last 4 years nominal in most applications.
- Non-volatile memory stores all programming and totalizer values even when batteries are removed.

Dimensions

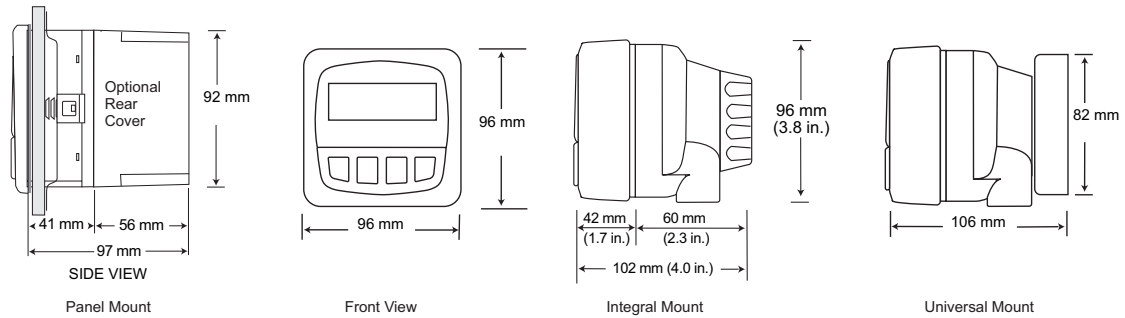

2. Specifications

General

Compatibility: Signet 515, 525, 2517 Flow Sensors
 Input Frequency Range: 1 to 400 Hz
 Accuracy: ±0.5% of reading

Enclosure:

- Rating: NEMA 4X/IP65 (front panel)
- Dimensions: 1/4 DIN (96 x 96 x 50 mm) (3.8 x 3.8 x 2.0 in.)
- Case material: PBT resin
- Keypad material: Sealed 4-key silicon rubber

Display: LCD type

- 4-digit upper line: flow rate
- 8-digit lower line: Three totalizer options:
 - Permanent Totalizer for life of instrument
 - Totalizer 1: resettable from keypad or remote 30 m (100 ft)
 - Totalizer 2: resettable with security code only
- Display Contrast: Automatic

Electrical:

- Battery: Two 3.6V Lithium thionyl chloride, AA-size
- Sensor power output: +3.6 VDC @ 20µA
- Battery life: 4 years nominal @ 50°C (122°F)
- Low Battery indication: Battery symbol on LCD display

Environmental:

- Operating Temperature: -10°C to 65°C (14°F to 149°F)
- Storage Temperature: -40 to 100°C (-40 to 212°F)
- Relative Humidity: 0 to 95% Non-condensing

Shipping Weight:

0.5 kg (1.1 lbs.)

Quality Standards:

- CE, CUL, UL
- EN 61326: 2002 Class B
- Manufactured under ISO 9001:2000 for Quality and ISO 14001:2004 for Environmental Management

3. Installation

3.1 Integral Installation with Field Mount Totalizer

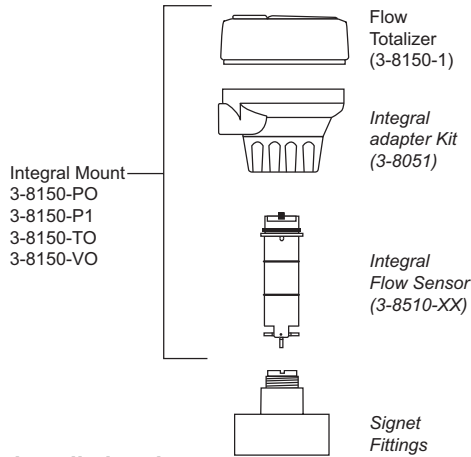

3.3 Plastic sensor installation tips

- Lubricate the sensor O-rings with a suitable lubricant. Do not use any petroleum based lubricant that will attack the O-rings.
- Using an alternating/twisting motion, lower the sensor into the fitting, making sure the installation arrows on the black cap are pointing in the direction of flow.
- Engage one thread of the sensor cap then turn the sensor until the alignment tab is seated in the fitting notch. Hand tighten the sensor cap. **DO NOT** use any tools on the sensor cap or the cap threads and/or fitting flange threads will be damaged.

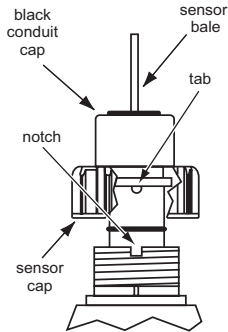

3.2 Remote Field mount on wall

The parts identified in **Bold type** are required for this installation. Other parts are shown for reference only. Use 2-conductor shielded cable no more than 30 m (100 ft.) long.

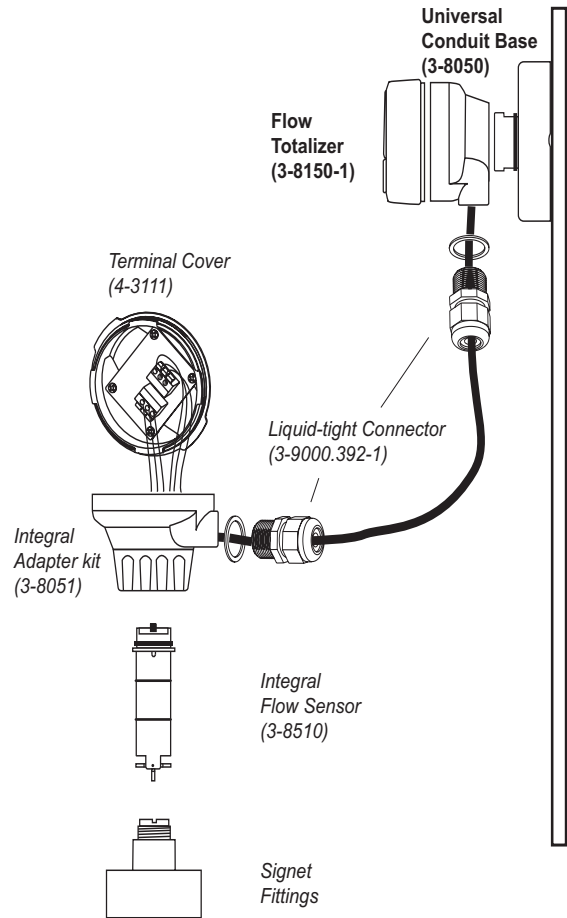

3.4 Conduit base Assembly Detail

1. Insert the wires from the sensor through the yellow conduit base and locking ring.
2. Insert the locking ring into the conduit base, aligning it so that the square tab is close to the conduit ports.
3. Insert the mounting screw into the conduit base so the head of the screw presses down on the locking ring when tightened.
4. Connect sensor wires to the terminal connections on the integral totalizer or terminal cover.
5. For remote assembly, connect output wires to terminal cover output.
6. Route the output wires through the conduit port in the conduit base. Use a liquid-tight connector or conduit connector to prevent moisture from entering the assembly.
7. Place totalizer or cover onto conduit base and twist to lock in place.

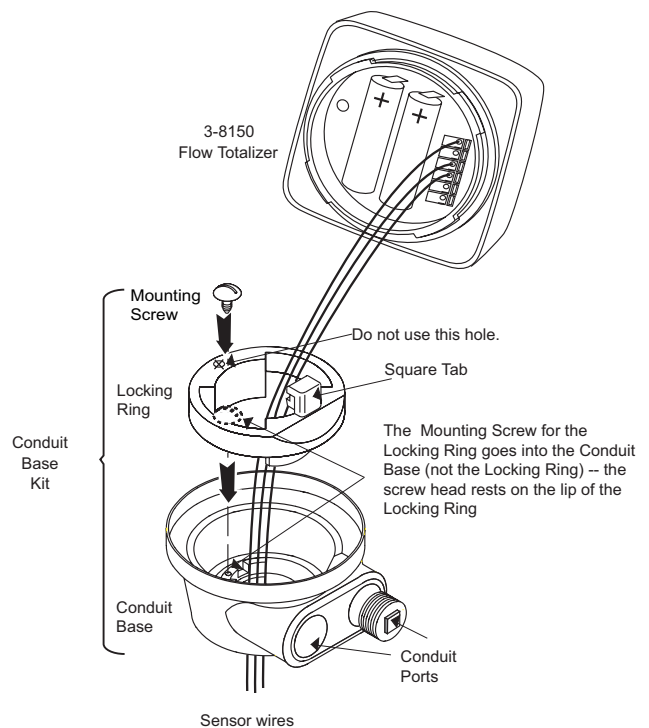

3.5 Remote Field mount on pipe

The parts identified in **Bold type** are required for this installation. Other parts are shown for reference only.

Use 2-conductor shielded cable no more than 30 m (100 ft.) long.

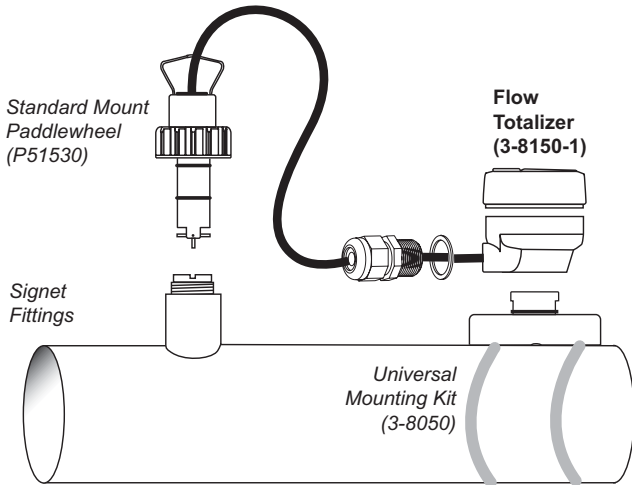

3.6 Remote Installation with Panel mount totalizer

The parts identified in **Bold type** are required for this installation. Other parts are shown for reference only.

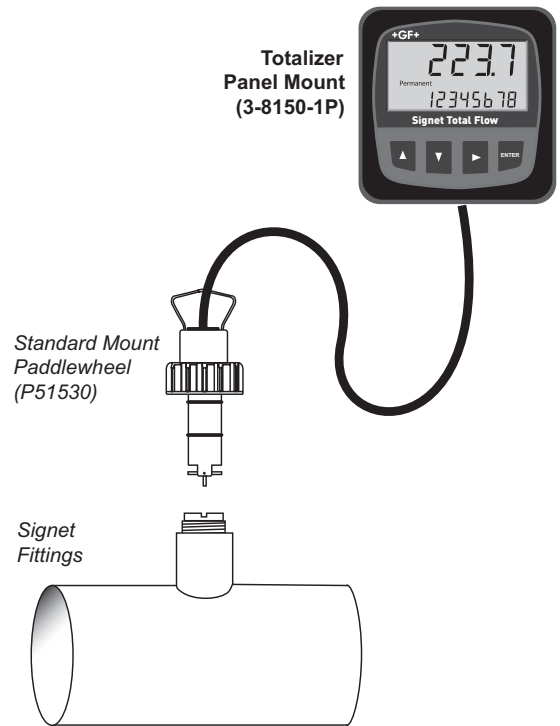

3.7 Panel Mount Installation Detail

- The 8150-1P Panel-mount Totalizer is a standard ¼ DIN package. Use a 92x92 mm punch tool to make the panel cutout.
- Minimum spacing of 25 mm (1 in.) between panel units is recommended.

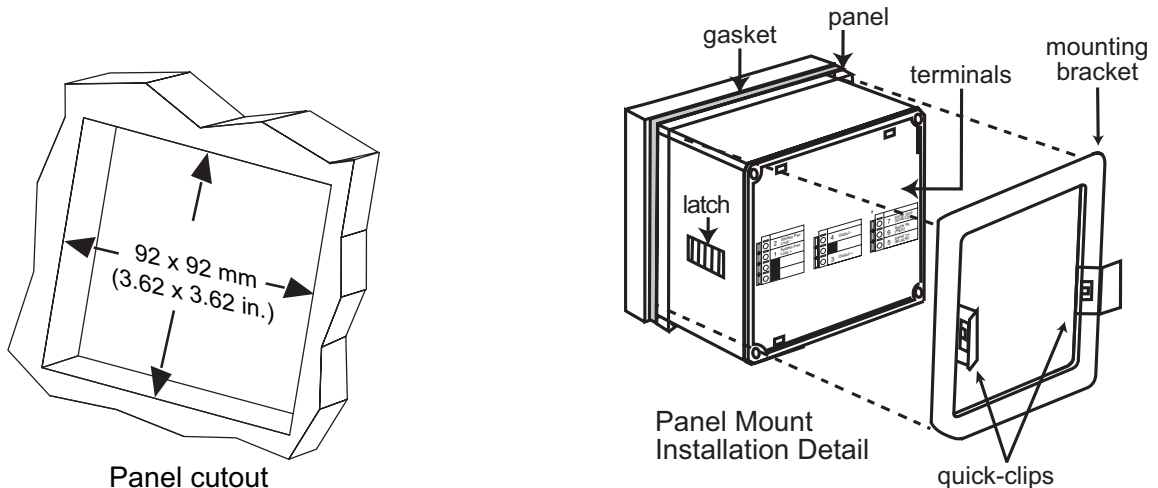

4. Wiring

- The wiring is identical for the panel mount and the field mount versions of the totalizer.
- Only one wire should be inserted into a terminal. Splice double wires outside the terminal.
- **External Reset for Total #1:** Use no more than 30 m (100 ft.) of 2-conductor twisted-pair cable connected to a dry contact (for example, an ordinary door-bell button or relay contact).
- Only Totalizer #1 can be reset by the external connection.
- Total #1 will not be displayed unless it is the standard totalizer selection.

Instructions

1. Remove 10mm ($\frac{3}{8}$ in.) of insulation from sensor cable conductors.
2. Press down on orange lever to open terminal.
3. Insert wire into terminal until it hits bottom.
4. Release the lever to secure wire.

10 mm



Sine wave Input Wiring

Use this wiring scheme for Signet models 515, 525 and 2517.

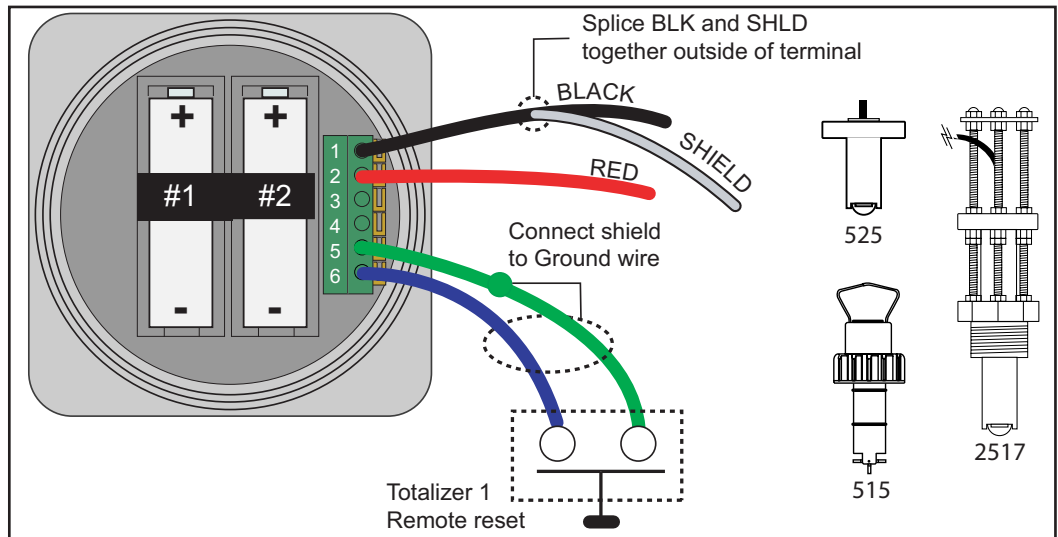

| Terminal no. | Function |
|--------------|-----------------------|
| 1 | Signal Ground |
| 2 | Sensor signal |
| 3 | Open Collector Signal |
| 4 | DC Power to sensor |
| 5 | Ground |
| 6 | Ext. Reset |

5. Battery Installation and Replacement

Two **3.6V Lithium thionyl chloride** batteries, AA-size (7400-0011) are included with the totalizer.

NOTE: THE 8150 WILL NOT OPERATE WITH STANDARD 1.5 V ALKALINE BATTERIES. USE 3.6 V LITHIUM BATTERIES ONLY!

- **Observe polarity!** Note that both batteries should face the same direction.
- When the “low battery” indicator appears on the display, both batteries should be replaced within 90 days.
- Remove and replace battery #1 first, then remove and replace battery #2. This ensures that all settings and totalizer values are saved.
- If the low battery symbol reappears for more than 10 seconds after installing new batteries, one battery is reversed, or battery #2 was installed before battery #1.
- Secure the batteries by fastening the Velcro® straps.

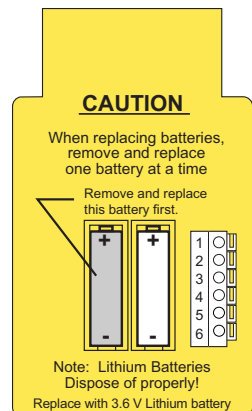

DISPOSE OF EXPENDED BATTERIES PROPERLY!

Lithium batteries contain hazardous chemicals. Dispose of batteries according to local regulation.

6. Operation

The 8150-1 display shows the flow rate in large numerals and a totalizer value in smaller numerals. Any one of three different totalizers can be selected as the standard display (See section 8 for detailed information on the totalizers).

Press the UP or DOWN keys to scroll through all three totalizer values during normal operation.

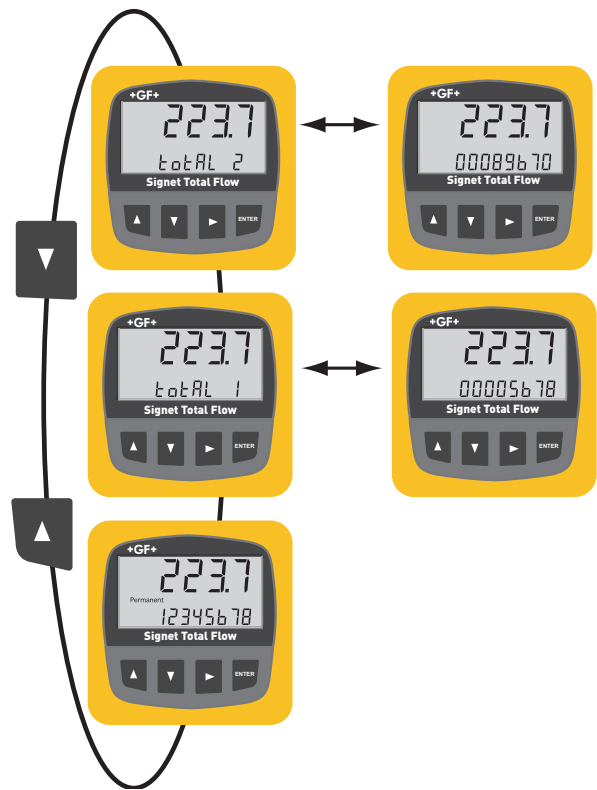

6.1 No Flow and ELAPSED TIME Display

If the flow stops, the Totalizer displays the number of hours since flow was last detected. This display will alternate with the normal FLOW RATE and standard TOTAL display every five seconds. Any movement of the rotor in the pipe will reset the ELAPSED TIME display.

Illustrated: No flow for 3 hours

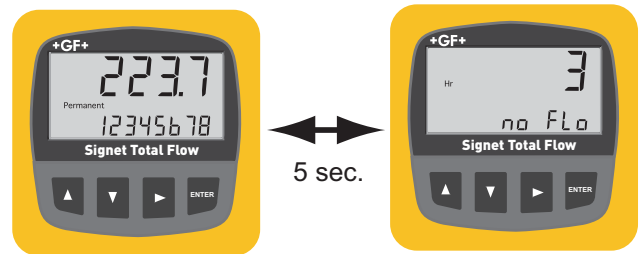

6.2 Standard menu settings

Totalizers are shipped from the factory with these standard settings:

| Function: | Factory set: | Description: |
|---------------------------|--------------|---|
| AUTO CALIBRATION | | No setting; See section 9 for detailed information. |
| FLOW K-FACTOR | 60 | Number of sensor pulses per volumetric unit; Refer to sensor manual. |
| TOTAL K-FACTOR | 1 | Set the number of volumetric units per totalizer count; see section 11. |
| TIMEBASE | Minutes | Select flow rate in seconds, minutes, hours or days. Section 12. |
| DECIMAL | XXX.X | Set the maximum decimal resolution. Section 13. |
| SPEED | 30 s | Zero to 120 seconds averaging stabilizes readings in erratic flow conditions. Section 14. |
| SENSITIVITY | 6 | Momentarily overrides SPEED when flow rate changes significantly. Section 15. |
| SECURITY CODE | 0-0-0-0 | Set a private code to prevent tampering. Section 7. |
| DEFAULT TOTALIZER | Permanent | Select from three totalizer options. Section 8. |
| TOTALIZER #2 RESET | | Reset Totalizer #2 after entering the security code. Section 8.3. |

7. Changing the Security Code

The security code prevents unauthorized tampering with calibration and operational settings in the 8150. The factory standard code is 0-0-0-0. Change the code to any 4-digit number by following these steps:

Example: Change the security code from the factory standard 0-0-0-0 to custom setting 1-0-0-1

1. Hold the ENTER key for 2 seconds, then enter the current SECURITY CODE.

If working with a new unit, press the ENTER key again. The display shows the first menu item (Auto CAL)

2. Press the UP key three times to scroll to Sec Code.

3. Press RIGHT ARROW to edit the code. The leading digit on the display will flash.

4. Press the UP key one time to scroll the flashing digit to 1.

5. Press the RIGHT key three times to advance the flashing element to the last digit.

6. Press the UP key one time to scroll the flashing digit to 1.

7. Press the ENTER key to complete the edit process.

8. Press the UP and DOWN keys together to exit the Calibrate menu, store the new settings and return to normal operation.

NOTE:

Record and store your security code in a safe place!

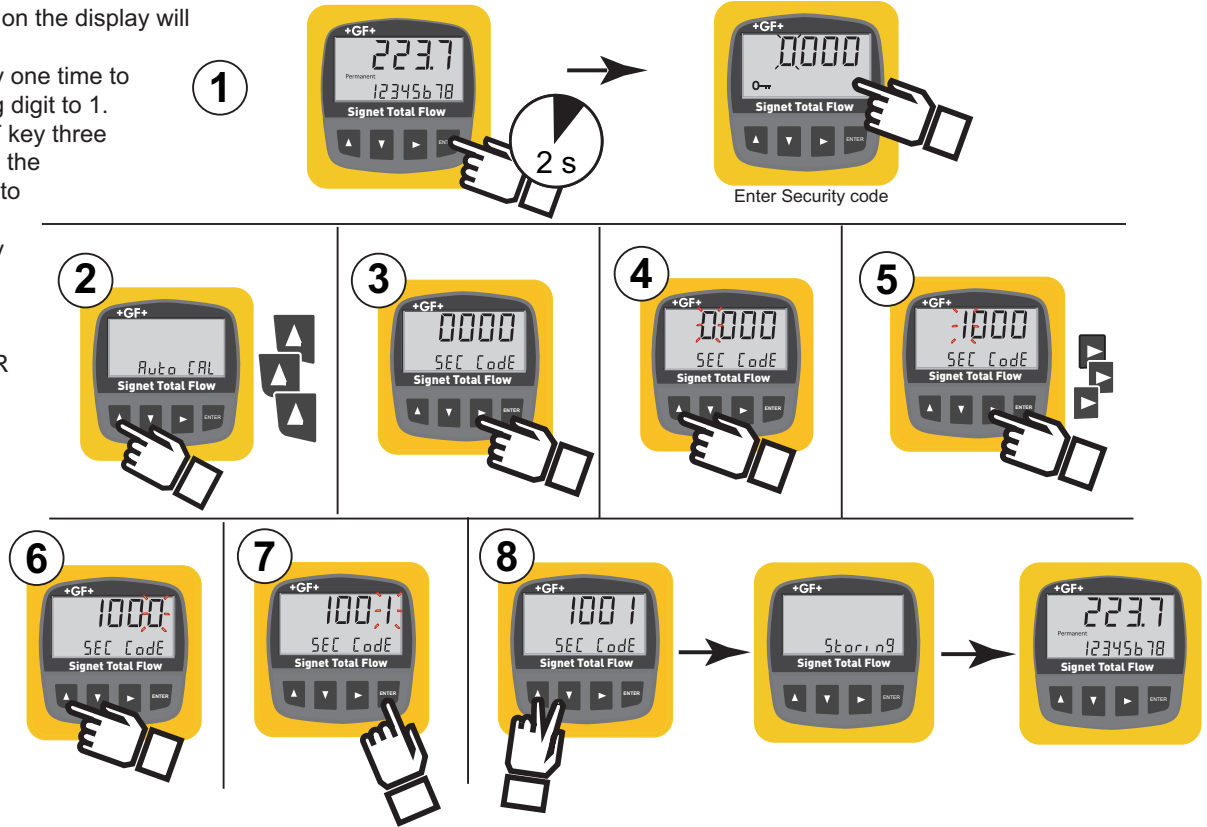

7.1 Using the Security Code

A numerical code (0-0-0-0 to 9-9-9-9) must be entered before any of the menu selections can be modified.

- The code is set at 0000 from the factory. To change the code, see section 7.

Example: Enter security code of 1001:

- Hold the ENTER key for 2 seconds. The display shows factory standard access code of 0000, with the first zero flashing.
- Press the UP key one time to scroll the flashing zero to 1.
- Press the RIGHT key three times to advance the flashing character to the last place value.
- Press the UP key one time to scroll the flashing zero to 1.
- Press the ENTER key. The display now shows the first item in the EDIT MENU.

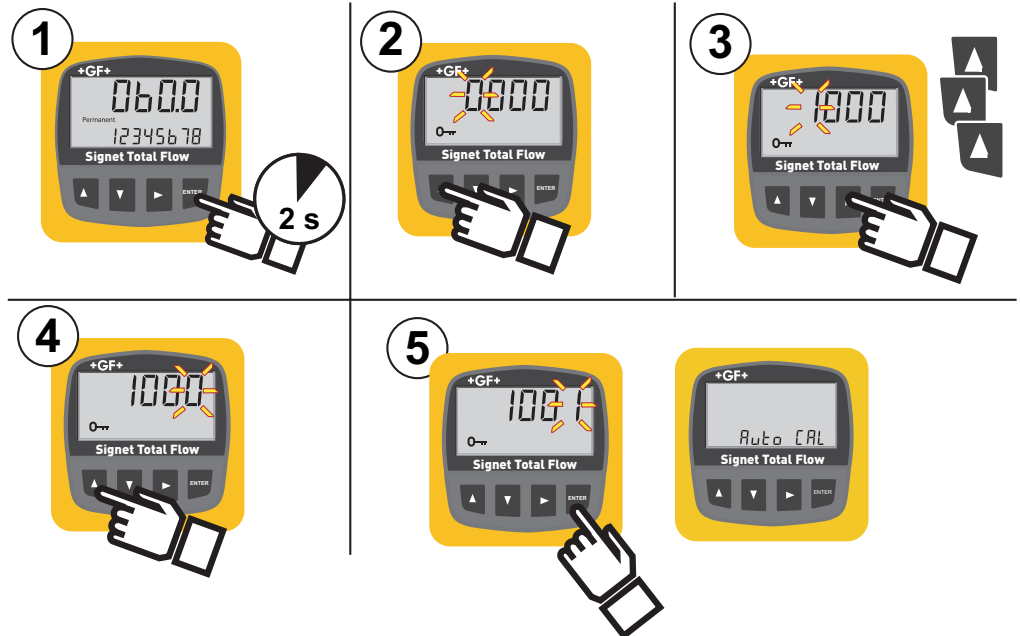

8. Totalizer Setup and Operation

During normal operation the 8150 displays the flow rate and one selected totalizer value. Any one of the three totalizers can be set as the standard display: The other two totalizers can be viewed by pressing the keypad. The display will automatically return to the standard selection after five minutes.

The **PERMANENT** Totalizer is identified directly on the LCD.

- This totalizer records all input from the time of manufacture.
- The permanent totalizer cannot be reset.
- Application: The permanent totalizer should be selected as the standard if the system is monitored and the total recorded regularly.

Total 1 (tot1) can be reset from the keypad or from the external RESET (see wiring, section 4) without the security code.

- **Total 1** is identified by a flashing display every six seconds.
- Application: Use Total 1 to measure water usage for a recurring period, as for a daily discharge volume.

Total 2 (tot2) can be reset only by entering the security code in the calibration menu.

- **Total 2** is identified by a flashing display every six seconds.
- Application: Use Total 2 for extended measurement periods, as for a monthly discharge volume.

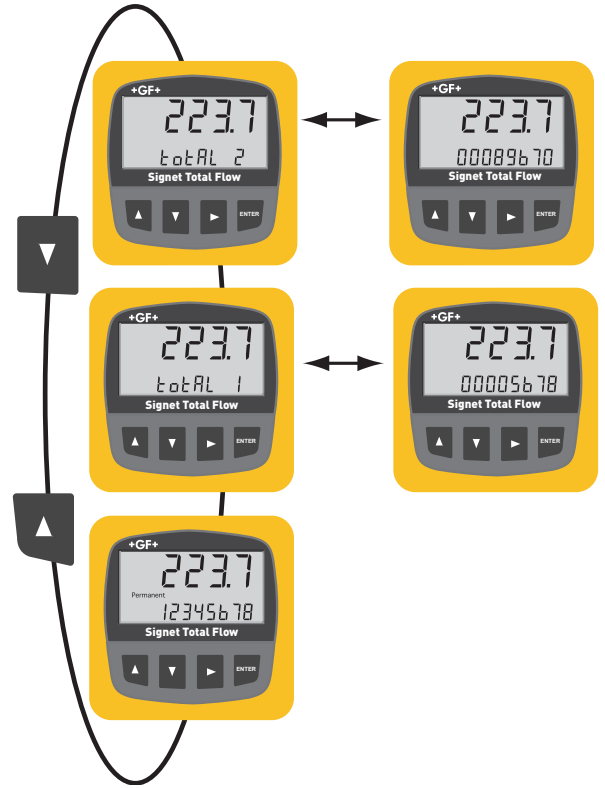

8.1 Define the standard Totalizer

Any of the three totalizer functions can be set as the standard display, or select SCAN to display all three totalizers in sequence. The PERMANENT totalizer is the factory standard selection.

Example: Change the standard Totalizer from PERMANENT to Totalizer #1

1. Press ENTER key for 2 seconds. (Display shows security key symbol and 0-0-0-0. Set security code and press ENTER key.)
2. Press UP key two times. Display shows "def tot" and the "PERMANENT" label.)
3. Press RIGHT ARROW key. (PERMANENT label begins to flash)
4. Press UP key one time. Display changes to flashing tot 1".
5. Press ENTER key to complete the edit process. The display will show "Storing" for a few seconds, then return to normal operation.
6. Press UP and DOWN keys together to store new value in the memory. NOTE: The new totalizer selection will appear after a 5 minute delay.

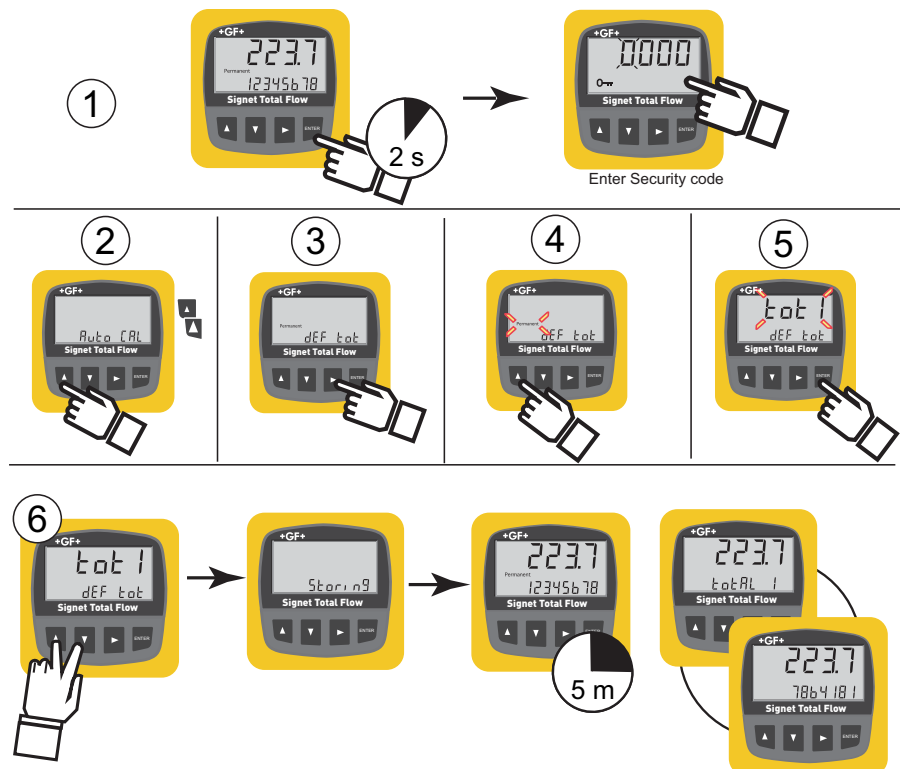

8.2 Resetting Totalizer 1

1. Press UP key to scroll to "total 1" display.
2. Press and hold the RIGHT arrow key until the display shows "rst tot1".
The totalizer will flash for 8 seconds and then it will automatically reset to 00000000.
- Press the ENTER key while the display is flashing to reset immediately.
- While the total value is flashing, you can cancel the reset by pressing UP and DOWN keys together.
- Totalizer #1 will be displayed for 5 minutes after the reset, then the standard totalizer selection will return.
- Press the UP or DOWN key to scroll back to the standard display immediately.

External Reset: See section 4: Wiring for information on resetting Totalizer #1 remotely from up to 30 meters distance. NOTE: When Total #1 is reset from an external switch, the display will not show totalizer #1 unless it has been set as the standard totalizer.

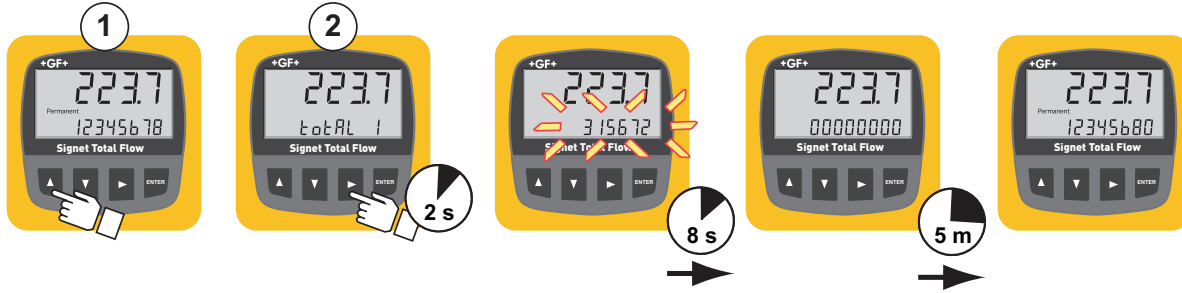

8.3 Resetting Totalizer 2

Totalizer #2 can be reset ONLY by entering the security code.

1. Press ENTER key for 2 seconds. (Display shows security key symbol and 0-0-0-0)
2. Set the security code in the flashing display and then press the ENTER key.
3. Press UP key one time. (Display shows "tot2 reset")
4. Press RIGHT ARROW key. The totalizer value will begin flashing.
The totalizer will automatically reset to 00000000 in 8 seconds.
While the display is flashing, you can cancel the reset by pressing UP and DOWN keys together.
5. Press UP and DOWN keys together to return to normal operation.

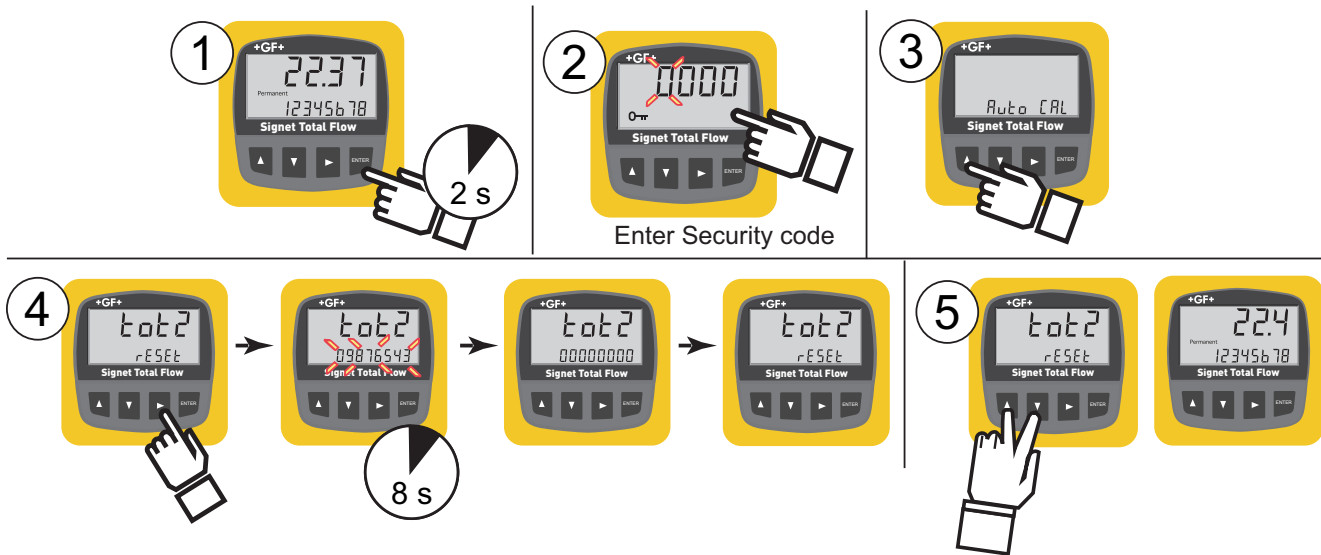

8.4 Saving Totalizer Values

To conserve battery life, totalizer values are stored in the memory every 12 hours. If both batteries are removed from the unit, the totalizers retain the last saved values, so the unit may lose several hours of data.

To prevent this loss, enter the security code, then enter any menu item and induce a "STORING" message. Whenever the 8150 stores a setting, it also stores all current totalizer data:

1. Enter the security code.
2. Press the UP key to scroll to the last item in the menu (DEFAULT TOTALIZER)
3. Press the RIGHT key to enter the edit mode (flashing display mode)
4. Press the ENTER key to retain the current settings.
5. Press the UP and DOWN keys simultaneously to initiate the "Storing" function.
The batteries can now be removed and replaced without losing any totals.

9. Auto CAL Calibration

The AutoCAL feature allows the Totalizer to be adjusted to match the flow rate to any external reference.

- Flow in the pipe should be as stable as possible for best results.
- If the flow rate display is erratic, set the SPEED (section 14) to 120 seconds during the Auto CAL procedure.
- The timebase on the reference meter must be the same as the 8150 Totalizer.

Example: The Totalizer flow rate shows 60 GPM, while an external reference indicates a true flow rate of 70 GPM. Change the flow rate from 60 GPM to 70 GPM using AutoCAL.

1. Hold the ENTER key for 2 seconds, then enter the SECURITY CODE.
Auto CAL is the first item in the menu.
2. Press the RIGHT key to select the Auto CAL function.
The display will show Auto CAL and the current flow rate will be flashing.
3. Press the RIGHT key again to change the flow rate. The display shows "Set Flo" and the first digit of the flow rate will begin flashing.
5. Press the RIGHT key to advance the flashing element to the "6".
5. Press the UP key one time to change the "6" to "7".
6. Press the ENTER key to complete the automatic calibration process.
The display shows a new K-factor with the first digit flashing. This K-factor is based on the change in flow rate.
7. Press the ENTER key again to accept the new value.
NOTE: If the display shows "**ERR SetFlo**" the procedure was unsuccessful because the calculated K-factor is less than 0.001 or greater than 999999. Verify the flow rate and start the Auto CAL procedure from step 1.
8. Press UP and DOWN keys together to store the new value in the memory.
The display will show "storing" for a few seconds, then return to normal operation.

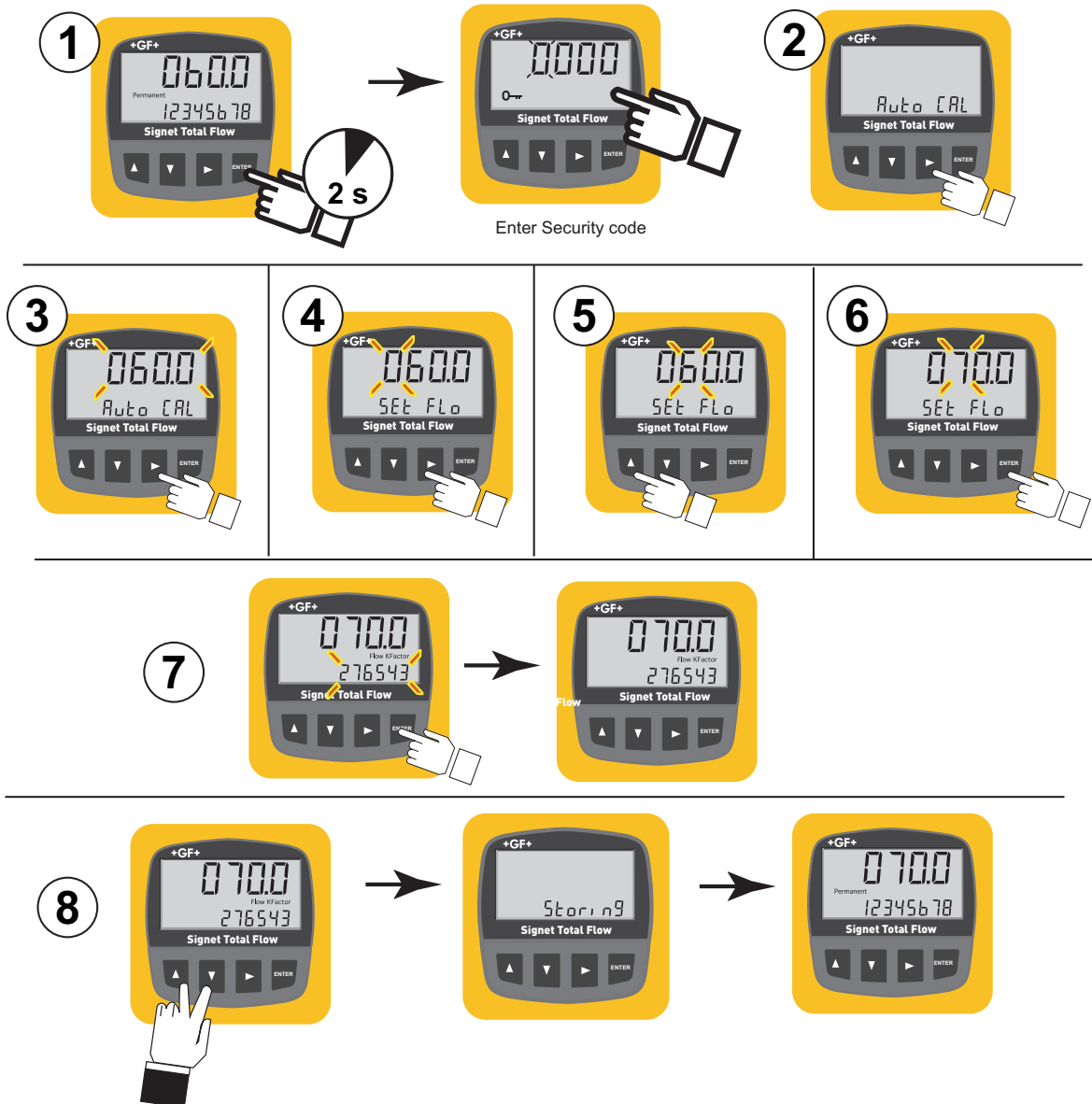

10. Flow K-factor

The K-factor is the number of pulses generated by the flow sensor for each measure of water that moves past the sensor.

Your flow sensor manual contains k-factor data in terms of U.S. Gallons and Liters.

Locate the K-factor that matches your pipe size material.

If necessary, you can convert the K-factor into other units of measure. The minimum K-factor value is 0.001, maximum value is 999999.

Example: Change the Flow K-factor from 060.000 to 095.000

1. Hold the ENTER key for 2 seconds, then enter the SECURITY CODE. (factory default is 0-0-0-0)
The display shows the first item in the menu (AutoCAL).
2. Press the DOWN key to scroll to the Flow K-factor. (the display shows the current K-factor setting)
3. Press the RIGHT key to select the Flow K-factor for editing. (The first element of the K-factor will begin flashing.)
4. Press the RIGHT key 1 time to advance the flashing element to the "6".
5. Press the UP key three times to change the "6" to "9".
6. Press the RIGHT key to advance the flashing element to the "0".
7. Press the DOWN key five times to change the "0" to "5".
8. Press the ENTER key to return to the CALIBRATE menu.
9. Press UP and DOWN keys together to store the new value and return to normal operation.

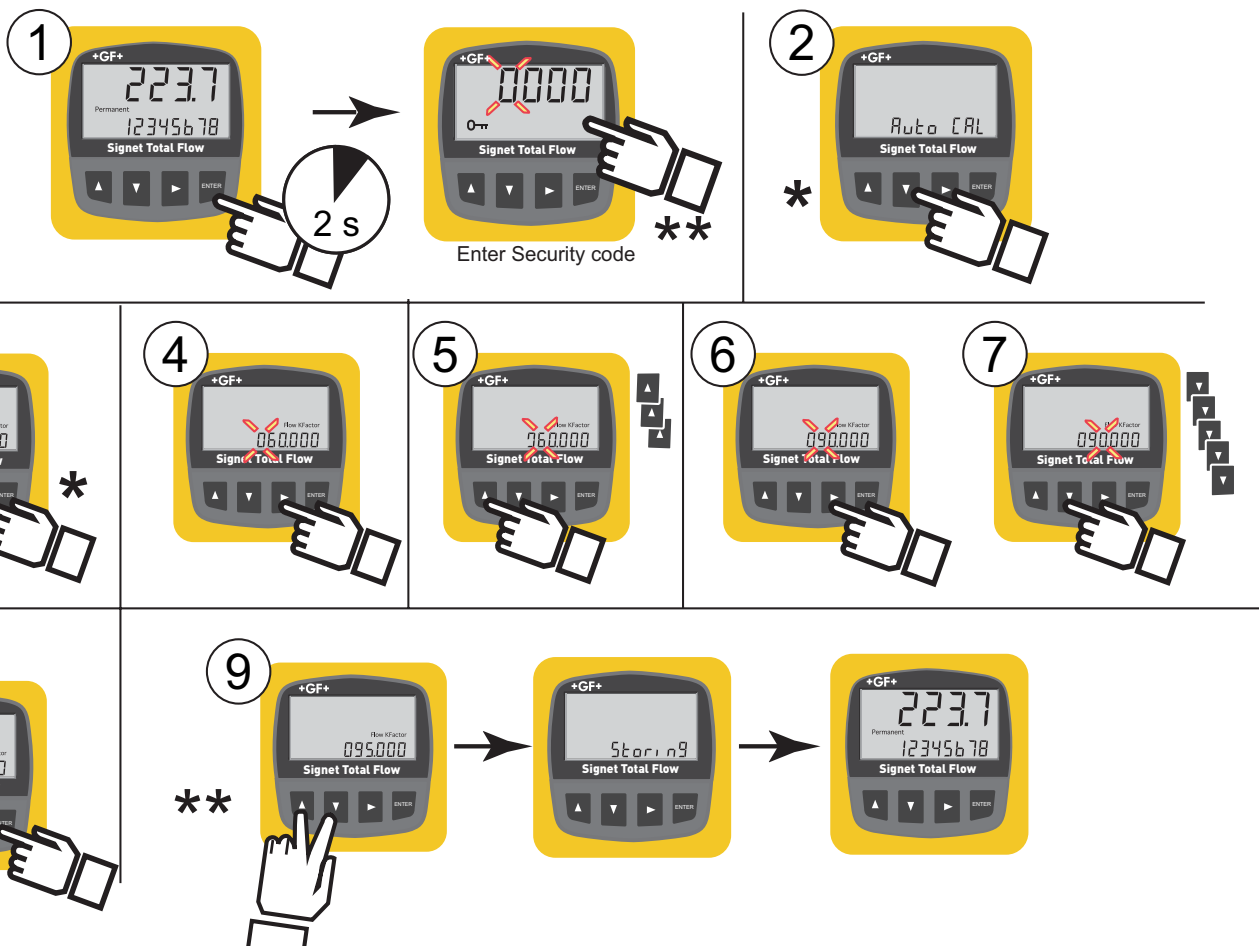

* Exit Without Changing?

As long as any element is flashing, you can abort the change and return to the original value by pressing UP and DOWN keys simultaneously.



** Finished Editing?

Press the UP and DOWN keys simultaneously from the main menu to return to normal operation.



11. Total K-factor

The TOTAL K-factor is a multiple of the FLOW K-factor. Use it to program the incremental count size of the totalizer.

For example, if the flow RATE registers in Litres per minute, the totalizer may be set to 1 (factory standard), so it counts in 1-Litre increments, or it may be set to 1000, so it counts in 1Kilolitre (1m³) increments.

By converting the Flow K-factor, the totalizer can also be set to count in other engineering units.

See sec. 17: "Flow and Total K-factor selection" for additional information about Total K-factor adjustments.

Example: Change the totalizer from 1 kiloLitre increments to count in 10-kiloLitre increments.

1. Hold the ENTER key for 2 seconds, then enter the SECURITY CODE.

The display shows the first item in the menu, AutoCAL.

2. Press the DOWN key two times to scroll to the Total K-factor.
3. Press the RIGHT key to select the Total K-factor for editing. The first element of the Total K-factor will begin flashing.
4. Press the RIGHT key six times to advance the flashing element to the decimal point.
5. Press the DOWN key one time to move the decimal point one position to the right.
6. Press the ENTER key to return to the menu.
7. Press UP and DOWN keys together to exit the menu and return to normal operation. The display shows "Storing" for a few seconds, then returns to the normal operating display.

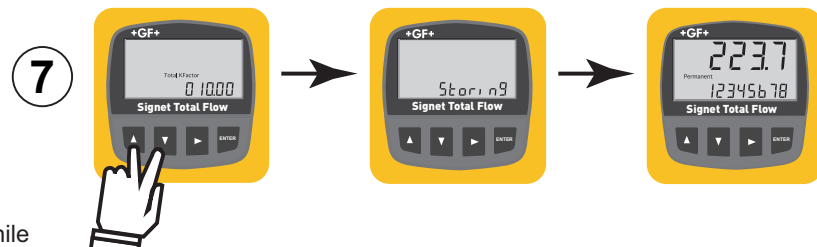
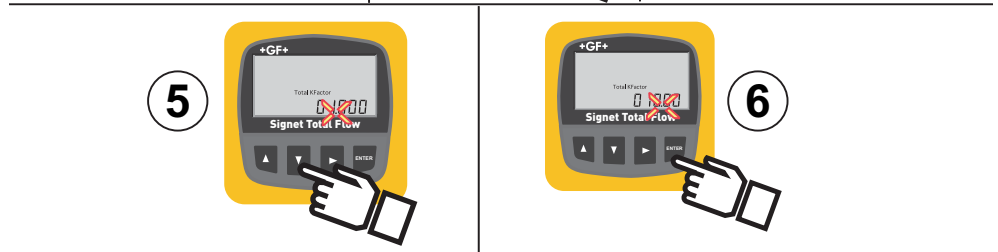
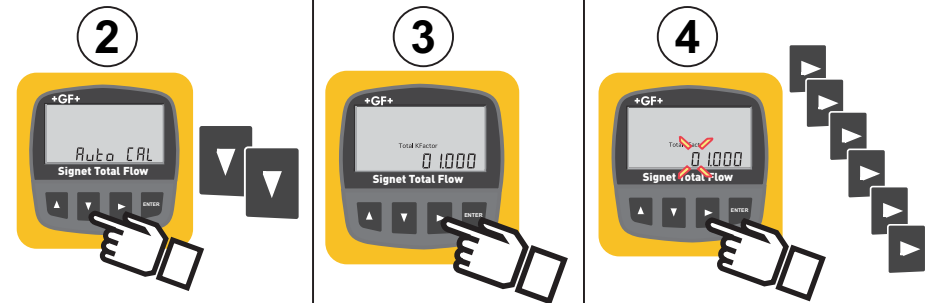

11.1 Adjusting the Flow K-factor

If the Totalizer yields a consistent error, make corrections by either using the AutoCal function (section 9) or by manually adjusting the Flow K-factor by the percentage of error.

A smaller K-factor increases the flowrate, while larger K-factors reduce the flow rate.

Example:

- The Flow K-factor is set at 480.19 pulses per Gallon.
- The totalizer registers 10 Gallons when the actual volume is known to be 11 Gallons.
- The error is 1 Gallon divided by 10 Gallons, or -10%. (The totalizer is counting 10% low, and the flow rate is reading 10% slow.)
- Reduce the Flow K-factor by 10%: $480.19 - 10\% = 432.17$.
- Change the Flow K-factor to 432 pulses per Gallon.

The result: The totalizer must count 10% fewer pulses from the flow sensor to register one Gallon, so both the totalizer and the flow rate will increase by 10%.

12. Time Base

Select the timebase for the flow rate. The available selections are seconds, minutes, hours or days.

Example: Change the Timebase from MINUTES (factory standard) to DAYS

1. Hold the ENTER key for 2 seconds, then enter the SECURITY CODE.
The display shows the first item in the CALIBRATE menu, AutoCAL.
2. Press the DOWN key three times to scroll to the Timebase.
3. Press the RIGHT key to select the Timebase for editing.
4. Press the UP key two times to scroll from MIN to DAY.
5. Press the ENTER key to return to the menu.
6. Press UP and DOWN keys together to exit the menu and return to normal operation.
The display shows "Storing" for a few seconds, then returns to the normal operating display.

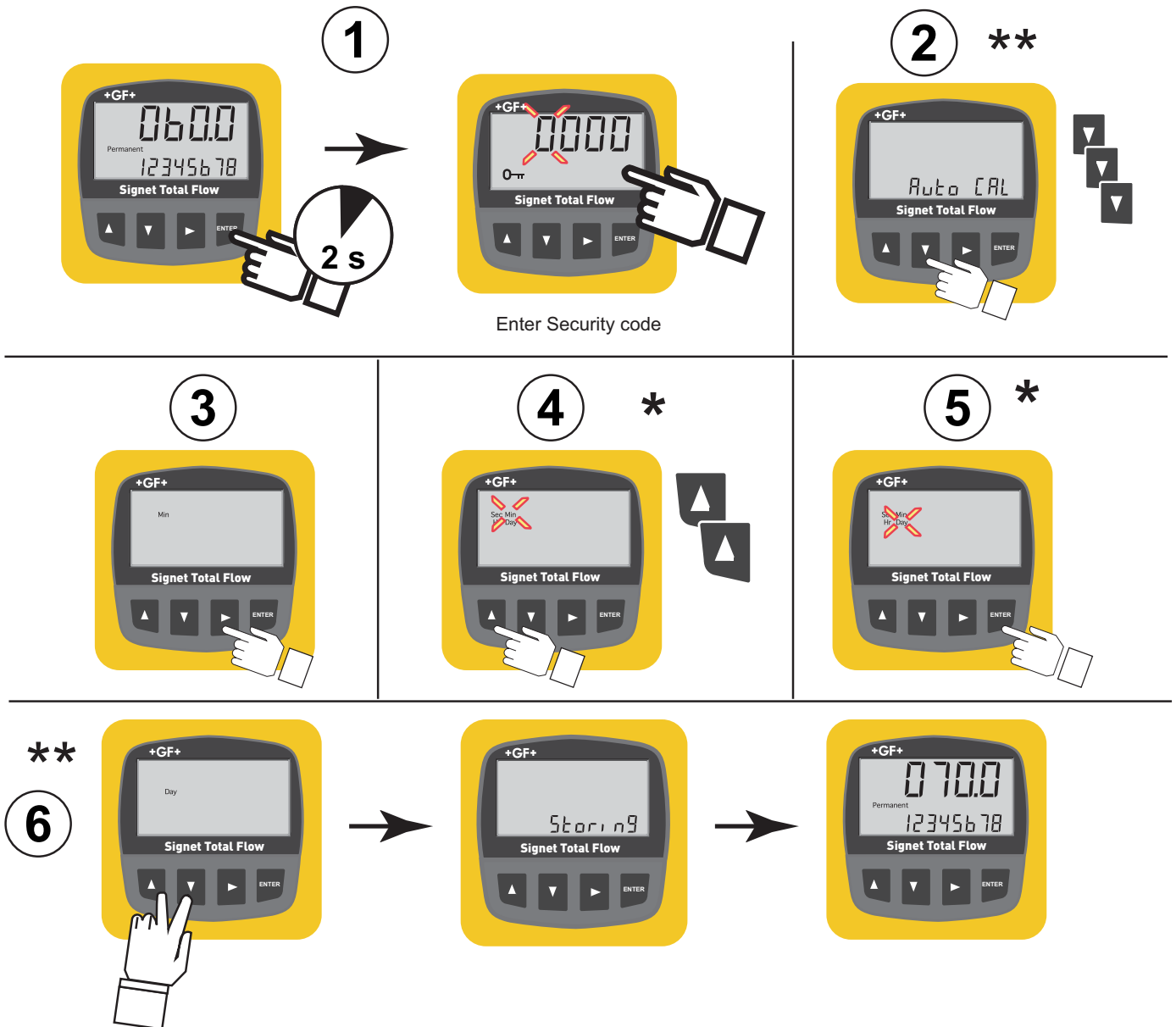

* Exit Without Changing?

As long as any element is flashing, you can abort the change and return to the original value by pressing UP and DOWN keys simultaneously.



** Finished Editing?

Press the UP and DOWN keys simultaneously from the main menu to return to normal operation.



13. Decimal point for Flow display

Select the maximum decimal resolution for the flow rate display. The available selections are hundredths (xx.xx) tenths (xxx.x) or whole numbers only (xxxx.) The decimal will auto-range down to this setting.

- If the decimal is set to whole numbers, the flow rate display will not auto-range.
- If the decimal is set to tenths, the flow rate display will show tenths up to 999.9, then the auto-range will switch to whole numbers (1000-to 9999.)
- If the decimal is set to hundredths, the flow rate display will show hundredths up to 99.99, then tenths from 100.1 to 999.9, then whole numbers to 9999.

| Available Display Selections | Your Flow rate | will read on display as: |
|------------------------------|----------------|--------------------------|
| hundredths (XX.XX) | 10.55 | 10.55 |
| tenths (XXX.X) | 10.55 | 10.6 |
| whole numbers (XXXX.) | 10.55 | 11 |

Example: Change the maximum decimal display from hundredths to tenths:

1. Hold the ENTER key for 2 seconds, then enter the SECURITY CODE.
The display shows the first item in the menu, AutoCAL.
2. Press the DOWN key four times to scroll to the Decimal setting.
The display shows four dashes and the current decimal setting.
3. Press the RIGHT key to select the decimal for editing.
The decimal point will begin to flash.
4. Press the DOWN key one time to move the flashing decimal

from hundredths to tenths.

5. Press the ENTER key to return to the menu.
The decimal will stop flashing.
6. Press UP and DOWN keys together to exit the menu and return to normal operation.
The display shows "Storing" for a few seconds, then returns to the normal operating display.

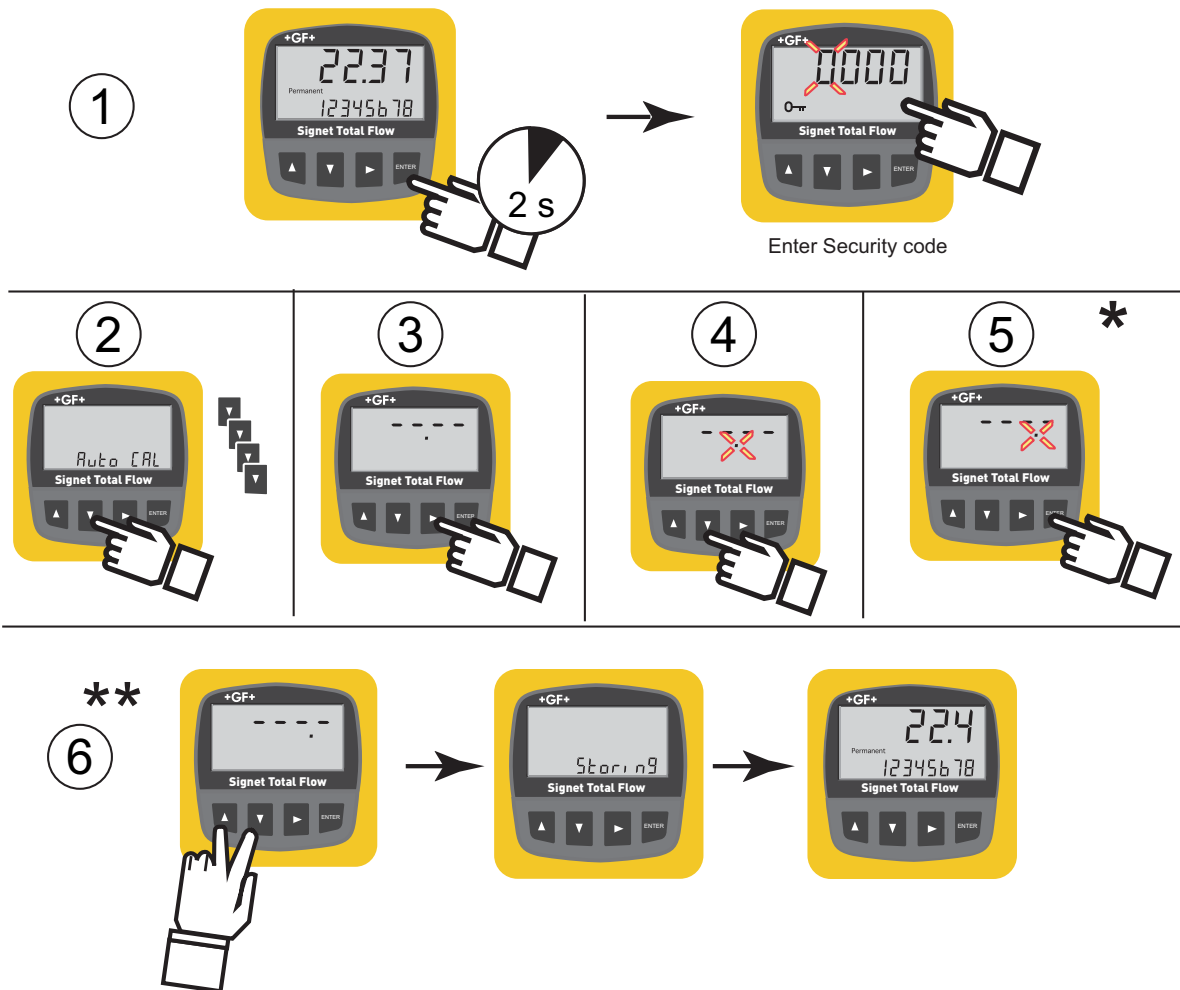

* Exit Without Changing?

As long as any element is flashing, you can abort the change and return to the original value by pressing UP and DOWN keys simultaneously.



** Finished Editing?

Press the UP and DOWN keys simultaneously from the main menu to return to normal operation.



14. Speed

SPEED averaging serves to smooth out fluctuations in the flow rate that may be caused by inadequate straight pipe runs after pumps, valves, and elbows in the pipe. The selections are 0, 7, 15, 30, 60 and 120 seconds. The factory standard setting is 30 seconds.

- Use faster (0-30 s) averaging for well-established, stable flow conditions.
- Use slower (60-120 s) averaging if the flow conditions are unstable.

Note: While the SPEED setting helps to smooth out the fluctuations caused by piping conditions, it also causes a delay in showing actual changes in flow rate. The SENSITIVITY function (section 15) is designed to help offset this effect.

Example: Change the SPEED setting from 60 seconds to 30 seconds.

1. Hold the ENTER key for 2 seconds, then enter the SECURITY CODE.
The display shows the first item in the CALIBRATE menu, AutoCAL.
2. Press the DOWN key five times to scroll to DISP SPEED.
The display shows DISP SPEED, the "sec" annunciator, and the current speed setting.
3. Press the RIGHT key to select the Display speed for editing.
The current speed selection begins flashing.
4. Press the DOWN key one time to scroll from 60 seconds to 30 seconds.
5. Press the ENTER key to return to the menu.
6. Press UP and DOWN keys together to exit the menu and return to normal operation.
The display shows "Storing" for a few seconds, then returns to the normal operating display.

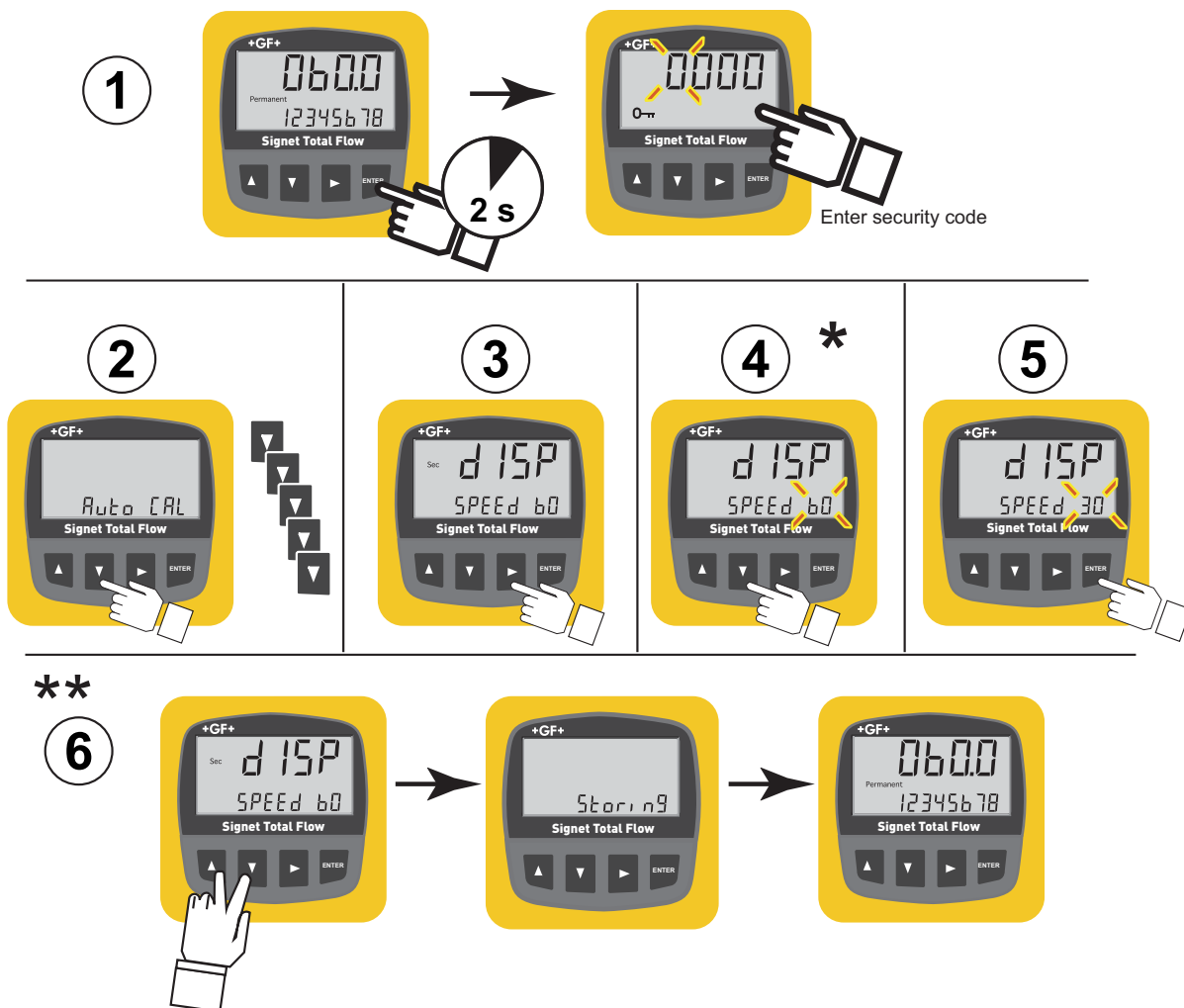

* Exit Without Changing?

As long as any element is flashing, you can abort the change and return to the original value by pressing UP and DOWN keys simultaneously.



** Finished Editing?

Press the UP and DOWN keys simultaneously from the main menu to return to normal operation.



15. Sensitivity

The SENSITIVITY setting determines how the 8150 responds to sudden surges in the flow rate. It "overrides" the SPEED function just long enough to allow an actual change in flow rate to be displayed, then resumes the averaging. The result is a smooth flow display and a quick response to large shifts in the flow rate.

■ ■ ■ ■ ■ No SPEED, no SENSITIVITY

With SPEED averaging set to 0 (zero) and with SENSITIVITY set to zero, the flow rate may be very unstable. This line represents the actual output of the flow sensor as it responds to unstable flow conditions in the pipe.

..... SPEED only

With SPEED set to 60 seconds and SENSITIVITY still set to zero the flow rate is stabilized, but a sharp change in flow rate is not represented for 60 seconds or longer. (dotted green line).

— SPEED and SENSITIVITY

With SPEED at 60 seconds and SENSITIVITY set to 6, the flow rate is stabilized, while the sudden shift in flow is reflected very quickly. (dotted blue line)

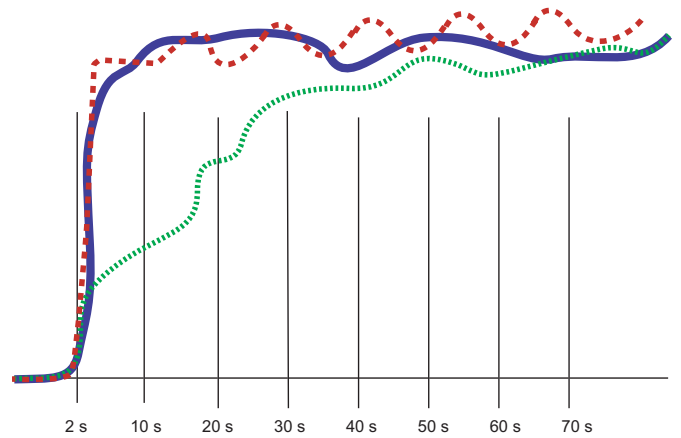



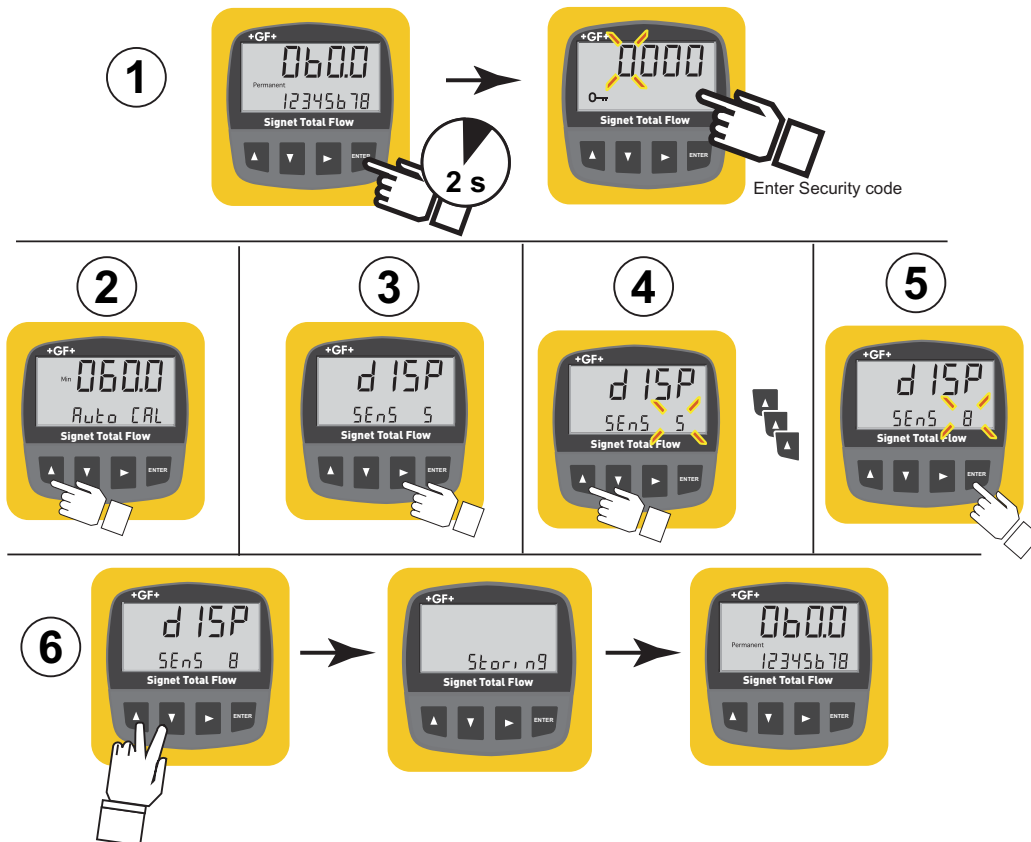

NOTE: The SENSITIVITY function is ineffective if the SPEED function is set to zero (seconds).

Example: Change the SENSITIVITY from 5 to 8

1. Hold the ENTER key for 2 seconds, then enter the SECURITY CODE.
The display shows the first item in the menu, AutoCAL.
2. Press the UP key once to scroll to SENSITIVITY.
The display shows DISP SENS and the current sensitivity setting.
3. Press the RIGHT key to select the SENSITIVITY for editing.
The current SENSITIVITY setting begins flashing.
4. Press the UP key three times to scroll from 5 to 8.
5. Press the ENTER key to return to the menu.
6. Press UP and DOWN keys together to exit the menu and return to normal operation.
The display shows "Storing" for a few seconds, then returns to the normal operating display.

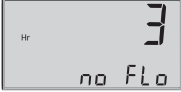

16. Troubleshooting

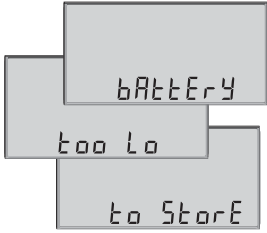
| Display Condition | Probable Cause | Suggested Solutions |
|--|---|---|
|  | Batteries are dead or missing | Replace both batteries. |
|  | The flow rate is greater than "9999" | <ol style="list-style-type: none"> 1. Reduce the flow rate. 2. Change the Timebase to a smaller value. (Example: Change from "Day" to "Hr".) 3. Change the flow units to a larger measure. (Example: Change from "Liters" to "Gallons".). NOTE: If the Flow K-factor is changed, be sure to make a corresponding change to the TOTAL K-factor. |
|  | 8150 is not receiving a signal from the flow sensor. | <ol style="list-style-type: none"> 1. There is no flow in the pipe. 2. Flow sensor is not turning due to blockage or damage. 3. Sensor wiring is loose or incorrect. |
|  | In AutoCal, the calculated K-factor is outside the range of the 8150. (less than 0.001 or greater than 99999) | Press RIGHT key to start Auto CAL procedure again. <u>Make sure that the flow rate entered is accurate.</u> |
| The flow rate display is erratic and non-linear | Usually caused by inadequate straight pipe run upstream of sensor. | <ol style="list-style-type: none"> 1. Correct piping layout to provide more straight pipe upstream of sensor. 2. Set the SPEED to higher setting to average out the fluctuations caused by piping conditions. (see Speed, section 14) |
|  | Both batteries are too depleted to safely store settings. | Replace battery #1, then replace battery #2. |

17. Flow and Total K-factor selection

Pages 17-19 provide K-factors for the Signet 515, 525, and 2517 flow sensors. Use this table to convert the K-factor to other units of measure, and to set the Total K-factor.

NOTE:

- The maximum K-factor is 999999.
- The minimum K-factor is 0.001.

| If you want the FLOW RATE to read in: | and you want the TOTALIZER to count in: | Set the Flow K-factor to: | and set the Total K-factor to: |
|---------------------------------------|---|---------------------------|--------------------------------|
| Liters | Liters | K(Liter) | 1 |
| Liters | Kiloliters | K(Liter) | 1000 |
| Liters | cubic meters | K(Liter) | 1000 |
| cubic meters | cubic meters | K(Liter) x 1000 | 1 |
| cubic meters | MegaLiters | K(Liter) x 1000 | 1000 |
| Kiloliters | Kiloliters | K(Liter) x 1000 | 1 |
| KiloLiters | MegaLiters | K(Liter) x 1000 | 1000 |
| MegaLiters | MegaLiters | K(Liter) x 1 000 000 | 1 |
| U.S. gallons | U.S. gallons | K(gal) | 1 |
| U.S. gallons | U.S. gallons x 1000 | K(gal) | 1000 |
| U.S. gallons | cubic feet | K(gal) | 7.4805 |
| U.S. gallons | acre inches | K(gal) | 27154 |
| U.S. gallons | Acre feet | K(gal) | 325848 |
| U.S. gallons | Kiloliters | K(gal) | 264.2 |
| Acre-Inches | Acre-Inches | K(gal) x 27154 | 1 |
| Acre-Inches | Acre feet | K(gal) x 27154 | 12 |
| Acre feet | Acre feet | K(gal) x 325848 | 1 |
| Acre feet | Acre-Inches | K(gal) x 325848 | 0.083 |
| cubic feet | cubic feet | K(gal) x 7.4805 | 1 |

18. K-factor Charts

18.1 515 Paddlewheel Flow Sensor

The following calibration data is reprinted from the instruction manual for the Signet 515 Flow sensor for your convenience.

| PIPE SIZE (IN.) | FITTING | 515/8510-XX | |
|---|----------|-------------|--------|
| | | U.S. GAL | LITERS |
| SCH 80 PVC TEES FOR SCH 80 PVC PIPE | | | |
| 1/2 | PV8T005 | 480.19 | 126.87 |
| 3/4 | PV8T007 | 257.72 | 68.090 |
| 1 | PV8T010 | 174.67 | 46.148 |
| 1-1/4 | PV8T012 | 83.390 | 22.032 |
| 1-1/2 | PV8T015 | 58.580 | 15.477 |
| 2 | PV8T020 | 32.480 | 8.5812 |
| 2-1/2 | PV8T025 | 21.833 | 5.7683 |
| 3 | PV8T030 | 13.541 | 3.5775 |
| 4 | PV8T040 | 7.6258 | 2.0147 |
| SCH 80 CPVC TEES FOR SCH 80 CPVC PIPE | | | |
| 1/2 | CPV8T005 | 480.19 | 126.87 |
| 3/4 | CPV8T007 | 257.72 | 68.090 |
| 1 | CPV8T010 | 174.67 | 46.148 |
| 1-1/4 | CPV8T012 | 83.390 | 22.032 |
| 1-1/2 | CPV8T015 | 58.580 | 15.477 |
| SCH 80 PVC SADDLES FOR SCH 80 PVC PIPE | | | |
| 2 | PV8S020 | 32.480 | 8.5812 |
| 2-1/2 | PV8S025 | 21.833 | 5.7683 |
| 3 | PV8S030 | 13.541 | 3.5775 |
| 4 | PV8S040 | 7.6258 | 2.0147 |
| 6 | PV8S060 | 4.1623 | 1.0997 |
| 8 | PV8S080 | 2.3705 | 0.6263 |
| 10 | PV8S100 | 1.5300 | 0.4042 |
| 12 | PV8S120 | 1.0600 | 0.2801 |
| SCH 80 PVC SADDLE ON SCH 40 PVC PIPE | | | |
| 2 | PV8S020 | 27.350 | 7.2259 |
| 2-1/2 | PV8S025 | 18.874 | 4.9866 |
| 3 | PV8S030 | 12.638 | 3.3389 |
| 4 | PV8S040 | 6.7282 | 1.7776 |
| 6 | PV8S060 | 3.7297 | 0.9854 |
| 8 | PV8S080 | 2.1527 | 0.5688 |
| 10 | PV8S100 | 1.3500 | 0.3567 |
| 12 | PV8S120 | 0.9600 | 0.2536 |
| PP CLAMP-ON SADDLE ON SCH 80 PP PIPE | | | |
| 10 | PPS100 | 1.5300 | 0.4042 |
| 12 | PPS120 | 1.0600 | 0.2801 |
| PP CLAMP-ON SADDLE ON SCH 40 PP PIPE | | | |
| 10 | PPS100 | 1.3500 | 0.3567 |
| 12 | PPS120 | 0.9600 | 0.2536 |

| PIPE SIZE (IN.) | FITTING | 515/8510-XX | |
|---|---------|-------------|--------|
| | | U.S. GAL | LITERS |
| CARBON STEEL TEES ON SCH 40 PIPE | | | |
| 1/2 | CS4T005 | 370.20 | 97.808 |
| 3/4 | CS4T007 | 212.06 | 56.027 |
| 1 | CS4T010 | 141.14 | 37.289 |
| 1-1/4 | CS4T012 | 60.655 | 16.025 |
| 1-1/2 | CS4T015 | 45.350 | 11.982 |
| 2 | CS4T020 | 26.767 | 7.0717 |
| STAINLESS STEEL TEES ON SCH 40 PIPE | | | |
| 1/2 | CR4T005 | 358.96 | 94.838 |
| 3/4 | CR4T007 | 202.61 | 53.530 |
| 1 | CR4T010 | 127.14 | 33.590 |
| 1-1/4 | CR4T012 | 61.910 | 16.357 |
| 1-1/2 | CR4T015 | 40.410 | 10.676 |
| 2 | CR4T020 | 22.300 | 5.8917 |
| GALVANIZED IRON TEES ON SCH 40 PIPE | | | |
| 1 | IR4T010 | 104.54 | 27.619 |
| 1-1/4 | IR4T012 | 62.979 | 16.639 |
| 1 1/2 | IR4T015 | 46.688 | 12.335 |
| 2 | IR4T020 | 29.459 | 7.7832 |
| BRONZE TEES ON SCH 40 PIPE | | | |
| 1 | BR4T010 | 104.54 | 27.619 |
| 1-1/4 | BR4T012 | 62.979 | 16.639 |
| 1-1/2 | BR4T015 | 46.688 | 12.335 |
| 2 | BR4T020 | 29.459 | 7.7832 |
| COPPER TEE FITTINGS ON COPPER PIPE SCH K | | | |
| 1/2 | CUKT005 | 443.21 | 117.10 |
| 3/4 | CUKT007 | 212.16 | 56.052 |
| 1 | CUKT010 | 127.18 | 33.600 |
| 1-1/4 | CUKT012 | 88.218 | 23.307 |
| 1-1/2 | CUKT015 | 56.962 | 15.049 |
| 2 | CUKT020 | 29.370 | 7.7595 |
| COPPER TEE FITTINGS ON COPPER PIPE SCH L | | | |
| 1/2 | CUKT005 | 414.41 | 109.49 |
| 3/4 | CUKT007 | 191.09 | 50.485 |
| 1 | CUKT010 | 119.84 | 31.662 |
| 1-1/4 | CUKT012 | 85.451 | 22.576 |
| 1-1/2 | CUKT015 | 55.160 | 14.573 |
| 2 | CUKT020 | 28.605 | 7.5575 |

| PIPE SIZE (IN.) | FITTING | 515/8510-XX | |
|---|---------|-------------|--------|
| | | U.S. GAL | LITERS |
| STAINLESS STEEL WELDOLETS ON SCH 40 PIPE | | | |
| 2-1/2 | CR4W025 | 18.800 | 4.9670 |
| 3 | CR4W030 | 12.170 | 3.2153 |
| 4 | CR4W040 | 6.9600 | 1.8388 |
| 5 | CR4W050 | 5.2600 | 1.3897 |
| 6 | CR4W060 | 3.6900 | 0.9749 |
| 8 | CR4W080 | 2.1300 | 0.5627 |
| 10 | CR4W100 | 1.3500 | 0.3567 |
| 12 | CR4W120 | 0.9600 | 0.2536 |
| CARBON STEEL WELDOLETS ON SCH 40 PIPE | | | |
| 2-1/2 | CS4W025 | 18.800 | 4.9670 |
| 3 | CS4W030 | 12.170 | 3.2153 |
| 4 | CS4W040 | 6.9600 | 1.8388 |
| 5 | CS4W050 | 5.2600 | 1.3897 |
| 6 | CS4W060 | 3.6900 | 0.9749 |
| 8 | CS4W080 | 2.1300 | 0.5627 |
| 10 | CS4W100 | 1.3500 | 0.3567 |
| 12 | CS4W120 | 0.9600 | 0.2536 |
| COPPER/BRONZE BRAZOLETS ON SCH 40 PIPE | | | |
| 2-1/2 | BR4B025 | 18.800 | 4.9670 |
| 3 | BR4B030 | 12.170 | 3.2153 |
| 4 | BR4B040 | 6.9600 | 1.8388 |
| 5 | BR4B050 | 5.2600 | 1.3897 |
| 6 | BR4B060 | 3.6900 | 0.9749 |
| 8 | BR4B080 | 2.1300 | 0.5627 |
| 10 | BR4B100 | 1.3500 | 0.3567 |
| 12 | BR4B120 | 0.9600 | 0.2536 |
| SCH 80 IRON SADDLES ON SCH 80 PIPE | | | |
| 2 | IR8S020 | 32.360 | 8.5495 |
| 2-1/2 | IR8S025 | 22.220 | 5.8705 |
| 3 | IR8S030 | 13.420 | 3.5456 |
| 4 | IR8S040 | 7.6600 | 2.0238 |
| 5 | IR8S050 | 5.8600 | 1.5482 |
| 6 | IR8S060 | 4.0900 | 1.0806 |
| 8 | IR8S080 | 2.3300 | 0.6156 |
| 10 | IR8S100 | 1.5300 | 0.4042 |
| 12 | IR8S120 | 1.0600 | 0.2801 |
| SCH 80 IRON SADDLE ON SCH 40 PIPE | | | |
| 2 | IR8S020 | 26.820 | 7.0859 |
| 2-1/2 | IR8S025 | 18.800 | 4.9670 |
| 3 | IR8S030 | 11.990 | 3.1678 |
| 4 | IR8S040 | 6.8500 | 1.8098 |
| 5 | IR8S050 | 5.3300 | 1.4082 |
| 6 | IR8S060 | 3.7600 | 0.9934 |
| 8 | IR8S080 | 2.1300 | 0.5627 |
| 10 | IR8S100 | 1.3500 | 0.3567 |
| 12 | IR8S120 | 0.9600 | 0.2536 |

18.1 515 Paddlewheel Flow Sensor (continued)

| PIPE SIZE | FITTING | 515/8510-XX | |
|---|---------|-------------|--------|
| | | U.S. GAL | LITERS |
| POLYPROPYLENE FITTINGS (DIN/ISO AND BS AND ANSI) | | | |
| DN 15 | PPMT005 | 481.55 | 127.23 |
| DN 20 | PPMT007 | 277.09 | 73.207 |
| DN 25 | PPMT010 | 141.18 | 37.300 |
| DN 32 | PPMT012 | 83.540 | 22.071 |
| DN 40 | PPMT015 | 51.265 | 13.544 |
| DN 50 | PPMT020 | 29.596 | 7.8193 |
| DN 65 | PPMT025 | 20.658 | 5.4579 |
| DN 80 | PPMT030 | 13.330 | 3.5218 |
| DN 100 | PPMT040 | 8.7077 | 2.3006 |
| DN 125 | PPMT050 | 5.0667 | 1.3386 |
| DN 150 | PPMT060 | 3.6892 | 0.9747 |
| DN 200 | PPMT080 | 2.0398 | 0.5389 |
| PVDF FITTINGS (DIN/ISO AND BS AND ANSI) | | | |
| DN 15 | SFMT005 | 420.87 | 111.19 |
| DN 20 | SFMT007 | 228.15 | 60.277 |
| DN 25 | SFMT010 | 136.70 | 36.116 |
| DN 32 | SFMT012 | 79.294 | 20.950 |
| DN 40 | SFMT015 | 43.490 | 11.490 |
| DN 50 | SFMT020 | 25.908 | 6.8450 |
| DN 65 | SFMT025 | 18.067 | 4.7732 |
| DN 80 | SFMT030 | 12.357 | 3.2648 |
| DN 100 | SFMT040 | 8.0599 | 2.1294 |
| DN 125 | SFMT050 | 4.4312 | 1.1707 |
| DN 150 | SFMT060 | 3.2271 | 0.8526 |
| DN 200 | SFMT080 | 2.0360 | 0.5379 |
| PVC FITTINGS (DIN/ISO) - EUROPE ONLY | | | |
| DN 15 | PVMT005 | 486.18 | 128.45 |
| DN 20 | PVMT007 | 242.85 | 64.160 |
| DN 25 | PVMT010 | 148.64 | 39.270 |
| DN 32 | PVMT012 | 85.125 | 22.490 |
| DN 40 | PVMT015 | 51.855 | 13.700 |
| DN 50 | PVMT020 | 29.750 | 7.8600 |
| DN 65 | PVMT025 | 17.487 | 4.6200 |
| DN 80 | PVMT030 | 12.491 | 3.3000 |
| DN 100 | PVMT040 | 8.1377 | 2.1500 |
| DN 150 | PVMT060 | 4.0878 | 1.0800 |
| DN 200 | PVMT080 | 2.0439 | 0.5400 |

18.2 525 Metalex Flow Sensor

The following data is reprinted from the Signet 525 Metalex Flow sensor manual for your convenience.

| SCH 40S STAINLESS STEEL PIPE PER ANSI B36.19 | | |
|---|---------------------|------------------|
| | K-FACTOR | K-FACTOR |
| PIPE SIZE | PULSES/ U.S. GAL | PULSES/ LITER |
| 1/2 IN. | 873.03 | 230.66 |
| 3/4 IN. | 515.41 | 136.17 |
| 1 IN. | 266.17 | 70.322 |
| 1 1/4 IN. | 148.84 | 39.324 |
| 1 1/2 IN. | 107.98 | 28.528 |
| 2 IN. | 64.808 | 17.122 |
| 2 1/2 IN. | 44.685 | 11.806 |
| 3 IN. | 28.579 | 7.5506 |
| 4 IN. | 16.302 | 4.3070 |
| 5 IN. | 10.237 | 2.7046 |
| 6 IN. | 7.0057 | 1.8509 |
| 8 IN. | 3.9641 | 1.0473 |
| 10 IN. | 2.4690 | 0.6523 |
| 12 IN. | 1.6894 | 0.4463 |

18.3 2517 High Performance Flow Sensor

The following data is reprinted from the Signet 2517 High Performance Flow sensor manual for for your convenience.

| SCH 40 WROUGHT STEEL PIPE PER ANSI B36.10 | | |
|--|---------------------|------------------|
| | K-FACTOR | K-FACTOR |
| PIPE SIZE | PULSES/ U.S. GAL | PULSES/ LITER |
| 1 1/2 | 122.000 | 32.232 |
| 2 | 78.690 | 20.790 |
| 2 1/2 | 55.630 | 14.697 |
| 3 | 35.530 | 9.3871 |
| 3 1/2 | 26.070 | 6.8877 |
| 4 | 19.840 | 5.2417 |
| 5 | 12.090 | 3.1942 |
| 6 | 8.0410 | 2.1244 |
| 8 | 4.3500 | 1.1493 |
| 10 | 2.6080 | 0.6890 |
| 12 | 1.7610 | 0.4653 |
| 14 | 1.4250 | 0.3765 |
| 16 | 1.0590 | 0.2798 |
| 18 | 0.8180 | 0.2161 |
| 20 | 0.6460 | 0.1707 |
| 22 | * | * |
| 24 | 0.4350 | 0.1149 |

| SCH 5S STAINLESS STEEL PIPE PER ANSI B36.19 | | |
|--|---------------------|------------------|
| | K-FACTOR | K-FACTOR |
| PIPE SIZE | PULSES/ U.S. GAL | PULSES/ LITER |
| 1 1/2 | 104.200 | 27.5297 |
| 2 | 67.160 | 17.7437 |
| 2 1/2 | 46.060 | 12.1691 |
| 3 | 29.790 | 7.8705 |
| 3 1/2 | 22.060 | 5.8283 |
| 4 | 16.890 | 4.4624 |
| 5 | 10.6500 | 2.8137 |
| 6 | 7.1160 | 1.8801 |
| 8 | 3.8700 | 1.0225 |
| 10 | 2.3570 | 0.6227 |
| 12 | 1.6060 | 0.4243 |
| 14 | 1.2980 | 0.3429 |
| 16 | 0.9620 | 0.2542 |
| 18 | 0.7400 | 0.1955 |
| 20 | 0.5900 | 0.1559 |
| 22 | 0.4790 | 0.1266 |
| 24 | 0.3990 | 0.1054 |

| "STD WROUGHT STEEL PIPE PER ANSI B36.10" | | |
|---|---------------------|------------------|
| | K-FACTOR | K-FACTOR |
| PIPE SIZE | PULSES/ U.S. GAL | PULSES/ LITER |
| 1 1/2 | 122.000 | 32.2325 |
| 2 | 78.690 | 20.7900 |
| 2 1/2 | 55.630 | 14.6975 |
| 3 | 35.530 | 9.3871 |
| 3 1/2 | 26.070 | 6.8877 |
| 4 | 19.840 | 5.2417 |
| 5 | 12.090 | 3.1942 |
| 6 | 8.0410 | 2.1244 |
| 8 | 4.3500 | 1.1493 |
| 10 | 2.6080 | 0.6890 |
| 12 | 1.7400 | 0.4597 |
| 14 | 1.3950 | 0.3686 |
| 16 | 1.0220 | 0.2700 |
| 18 | 0.7800 | 0.2061 |
| 20 | 0.6150 | 0.1625 |
| 22 | 0.4970 | 0.1313 |
| 24 | 0.4110 | 0.1086 |

| SCH 40S STAINLESS STEEL PIPE PER ANSI B36.19 | | |
|---|---------------------|------------------|
| | K-FACTOR | K-FACTOR |
| PIPE SIZE | PULSES/ U.S. GAL | PULSES/ LITER |
| 1 1/2 | 122.000 | 32.2325 |
| 2 | 78.690 | 20.7900 |
| 2 1/2 | 55.630 | 14.6975 |
| 3 | 35.530 | 9.3871 |
| 3 1/2 | 26.070 | 6.8877 |
| 4 | 19.840 | 5.2417 |
| 5 | 12.090 | 3.1942 |
| 6 | 8.0410 | 2.1244 |
| 8 | 4.3500 | 1.1493 |
| 10 | 2.6080 | 0.6890 |
| 12 | 1.7400 | 0.4597 |
| 14 | * | * |
| 16 | * | * |
| 18 | * | * |
| 20 | * | * |
| 22 | * | * |
| 24 | * | * |

| SCH 80 WROUGHT STEEL PIPE PER ANSI B36.10 | | |
|--|---------------------|------------------|
| | K-FACTOR | K-FACTOR |
| PIPE SIZE | PULSES/ U.S. GAL | PULSES/ LITER |
| 1 1/2 | 136.100 | 35.9577 |
| 2 | 88.590 | 23.4055 |
| 2 1/2 | 62.810 | 16.5945 |
| 3 | 39.990 | 10.5654 |
| 3 1/2 | 29.220 | 7.7199 |
| 4 | 22.160 | 5.8547 |
| 5 | 13.420 | 3.5456 |
| 6 | 9.0160 | 2.3820 |
| 8 | 4.8190 | 1.2732 |
| 10 | 2.8970 | 0.7654 |
| 12 | 1.9620 | 0.5184 |
| 14 | 1.5890 | 0.4198 |
| 16 | 1.1750 | 0.3104 |
| 18 | 0.9040 | 0.2388 |
| 20 | 0.7160 | 0.1892 |
| 22 | 0.5820 | 0.1538 |
| 24 | 0.4820 | 0.1273 |

| SCH 10S STAINLESS STEEL PIPE PER ANSI B36.19 | | |
|---|---------------------|------------------|
| | K-FACTOR | K-FACTOR |
| PIPE SIZE | PULSES/ U.S. GAL | PULSES/ LITER |
| 1 1/2 | 113.600 | 30.0132 |
| 2 | 72.560 | 19.1704 |
| 2 1/2 | 48.750 | 12.8798 |
| 3 | 31.250 | 8.2563 |
| 3 1/2 | 23.010 | 6.0793 |
| 4 | 17.540 | 4.6341 |
| 5 | 10.8700 | 2.8719 |
| 6 | 7.2410 | 1.9131 |
| 8 | 3.9520 | 1.0441 |
| 10 | 2.3880 | 0.6309 |
| 12 | 1.6200 | 0.4280 |
| 14 | 1.3110 | 0.3464 |
| 16 | 0.9680 | 0.2557 |
| 18 | 0.7440 | 0.1966 |
| 20 | 0.5930 | 0.1567 |
| 22 | 0.4820 | 0.1273 |
| 24 | 0.4020 | 0.1062 |

| "XS WROUGHT STEEL PIPE PER ANSI B36.10" | | |
|--|---------------------|------------------|
| | K-FACTOR | K-FACTOR |
| PIPE SIZE | PULSES/ U.S. GAL | PULSES/ LITER |
| 1 1/2 | 136.100 | 35.9577 |
| 2 | 88.590 | 23.4055 |
| 2 1/2 | 62.810 | 16.5945 |
| 3 | 39.990 | 10.5654 |
| 3 1/2 | 29.220 | 7.7199 |
| 4 | 22.160 | 5.8547 |
| 5 | 13.420 | 3.5456 |
| 6 | 9.0160 | 2.3820 |
| 8 | 4.8190 | 1.2732 |
| 10 | 2.7730 | 0.7326 |
| 12 | 1.8240 | 0.4819 |
| 14 | 1.4550 | 0.3844 |
| 16 | 1.0590 | 0.2798 |
| 18 | 0.8050 | 0.2127 |
| 20 | 0.6320 | 0.1670 |
| 22 | 0.5100 | 0.1347 |
| 24 | 0.4200 | 0.1110 |

| SCH 80S STAINLESS STEEL PIPE PER ANSI B36.19 | | |
|---|---------------------|------------------|
| | K-FACTOR | K-FACTOR |
| PIPE SIZE | PULSES/ U.S. GAL | PULSES/ LITER |
| 1 1/2 | 136.100 | 35.9577 |
| 2 | 88.590 | 23.4055 |
| 2 1/2 | 62.810 | 16.5945 |
| 3 | 39.990 | 10.5654 |
| 3 1/2 | 29.220 | 7.7199 |
| 4 | 22.160 | 5.8547 |
| 5 | 13.420 | 3.5456 |
| 6 | 9.0160 | 2.3820 |
| 8 | 4.8190 | 1.2732 |
| 10 | 2.7730 | 0.7326 |
| 12 | 1.8240 | 0.4819 |
| 14 | * | * |
| 16 | * | * |
| 18 | * | * |
| 20 | * | * |
| 22 | * | * |
| 24 | * | * |

| Schedule 40 Plastic pipe per ASTM-D-1785 | | |
|---|---------------------|------------------|
| | K-FACTOR | K-FACTOR |
| PIPE SIZE | PULSES/ U.S. GAL | PULSES/ LITER |
| 1 1/2 | 124.400 | 32.8666 |
| 2 | 80.140 | 21.1731 |
| 2 1/2 | 56.730 | 14.9881 |
| 3 | 36.180 | 9.5588 |
| 3 1/2 | 26.500 | 7.0013 |
| 4 | 20.140 | 5.3210 |
| 5 | 12.250 | 3.2365 |
| 6 | 8.1430 | 2.1514 |
| 8 | 4.3980 | 1.1620 |
| 10 | 2.6340 | 0.6959 |
| 12 | 1.7770 | 0.4695 |

| "Schedule 80 Plastic pipe per ASTM-D-1785" | | |
|---|---------------------|------------------|
| | K-FACTOR | K-FACTOR |
| PIPE SIZE | PULSES/ U.S. GAL | PULSES/ LITER |
| 1 1/2 | 139.400 | 36.8296 |
| 2 | 90.790 | 23.9868 |
| 2 1/2 | 64.610 | 17.0700 |
| 3 | 41.050 | 10.8454 |
| 3 1/2 | 29.940 | 7.9102 |
| 4 | 22.660 | 5.9868 |
| 5 | 13.700 | 3.6196 |
| 6 | 9.1990 | 2.4304 |
| 8 | 4.9060 | 1.2962 |
| 10 | 2.9450 | 0.7781 |
| 12 | 1.9930 | 0.5266 |

19. Ordering Information

| Mfr. Part No. | Code | Description |
|---------------|-------------|--|
| 3-8150-1 | 159 000 929 | Flow Totalizer |
| 3-8150-1P | 159 000 930 | Flow Totalizer, Panel Mount |
| 3-8150-P0 | 159 000 931 | Flow Totalizer system, Integral, for 0.5 to 4 in. pipes, PP housing, Blk PVDF rotor, Titanium pin |
| 3-8150-P1 | 159 000 932 | Flow Totalizer system, Integral, for 0.5 to 8 in. pipes, PP housing, Blk PVDF rotor, Titanium pin |
| 3-8150-T0 | 159 001 011 | Flow Totalizer system, Integral, for 0.5 to 4 in. pipes, natural PVDF housing, rotor and pin |
| 3-8150-V0 | 159 001 012 | Flow Totalizer system, Integral, for 0.5 to 4 in. pipes, natural PVDF housing and rotor, Hastelloy pin |

Parts and Accessories

Mounting

| | | |
|--------------|-------------|--|
| 3-8050 | 159 000 184 | Universal mounting kit |
| 3-0000.596 | 159 000 641 | Heavy duty wall mount bracket (for panel mount only) |
| 3-5000.598 | 198 840 225 | Surface mount bracket |
| 3-8050.395 | 159 000 186 | Splashproof rear cover for panel mount totalizer |
| 3-9000.392 | 159 000 368 | Liquid tight connector kit (includes 3 connectors) |
| 3-9000.392-1 | 159 000 839 | Liquid tight connector, NPT (1 connector) |
| 3-9000.392-2 | 159 000 841 | Liquid tight connector, PG 13.5 (1 connector) |

| | | |
|------------|-------------|---------------------------------------|
| 3-8050.392 | 159 000 640 | Model 200 retrofit adaptor |
| 7400-0011 | 159 000 935 | Lithium battery, 3.6V, AA size |
| 5523-0222 | 159 000 392 | Cable, two conductor shielded, 22 AWG |

Replacement parts for integral mount units

| | | |
|-----------|-------------|--|
| 3-8051 | 159 000 187 | Flow integral mounting kit, NPT replacement) |
| 3-8510-P0 | 198 864 504 | Sensor for 0.5 to 4 in. pipes, Polypropylene housing, titanium pin, Blk PVDF rotor |
| 3-8510-P1 | 198 864 505 | Sensor for 5 to 8 in. pipes, Polypropylene body |
| 3-8510-T0 | 159 000 622 | Sensor for 0.5 to 4 in. pipes, natural PVDF housing, rotor and pin |
| 3-8510-V0 | 198 864 506 | Sensor for 0.5 to 4 in. pipes, natural PVDF housing and rotor, Hastelloy pin |

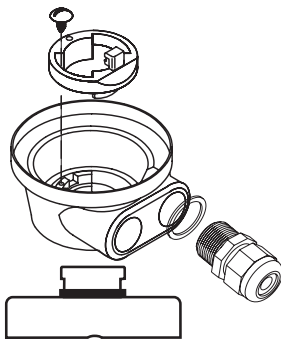

3-8050
Universal mounting kit



Flow Totalizer
Panel Mount
3-8150-1P

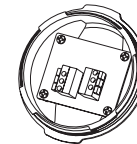

Terminal Cover
4-3111



Flow
Totalizer
(3-8150-1)

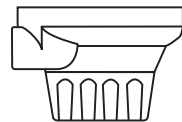

*Integral
adapter Kit
(3-8051)*

Integral System
3-8150-P0
3-8150-P1
3-8150-T0
3-8150-V0

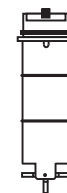

*Integral
Flow Sensor
(3-8510-XX)*

+GF+

George Fischer Signet, Inc. 3401 Aerojet Avenue, El Monte, CA 91731-2882 U.S.A. • Tel. (626) 571-2770 • Fax (626) 573-2057
For Worldwide Sales and Service, visit our website: www.gfsignet.com • Or call (in the U.S.): (800) 854-4090

