

NUFLO™

# MC-III™ WP Flow Analyzer

## User Manual



# Important Safety Information

## *Symbols Used in this Manual*

WARNING



This symbol identifies information about practices or circumstances that can lead to personal injury or death, property damage, or economic loss.

## *Terms Used in this Manual*

**Caution:** Indicates actions or procedures which if not performed correctly may lead to personal injury or incorrect function of the instrument or connected equipment.

**Important:** Indicates actions or procedures which may affect instrument operation or may lead to an instrument response which is not planned.

## *Symbols Marked on Equipment*



Attention! Refer to manual

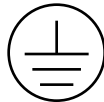

Protective (earth) ground

## *Technical Support Contact Information*

Cameron  
Measurement Systems Division  
14450 John F. Kennedy Blvd.  
Houston, TX 77032  
Phone: 1-800-654-3760; 281-582-9500  
Fax: 281-582-9599

NuFlo and MC-III are trademarks of Cameron International Corporation ("Cameron").

Modbus is a registered trademark of the Modbus Organization, Inc.

Windows is a registered trademark of Microsoft Corporation.

Acrobat Reader is a registered trademark of Adobe Systems Incorporated.

© 2013 Cameron International Corporation ("Cameron"). All information contained in this publication is confidential and proprietary property of Cameron. Any reproduction or use of these instructions, drawings, or photographs without the express written permission of an officer of Cameron is forbidden.

All Rights Reserved.  
Printed in the United States of America.

Manual No. 9A-50165009, Rev. 03  
August 2013

## Contents

<b>Section 1—Introduction</b> .....	<b>1</b>
Operation .....	1
Key Product Features .....	4
LCD Display .....	4
Keypad .....	5
Interface Software .....	6
Power Supply .....	6
Multipoint Linearization .....	7
Gas Volume Correction .....	7
Input Options .....	7
Output Options .....	7
Flow Log Archival .....	7
Event Log Archival .....	7
Password-Protected Security .....	7
Commonly Used Functions .....	8
Reading Totals .....	8
Saving Totals to Memory .....	8
Resetting the Total .....	8
Viewing Daily and Hourly Logs .....	8
Saving and Uploading Configuration Files .....	9
Exporting Log Data .....	9
Saving Log Data in a Report .....	9
<b>Section 2—Installation</b> .....	<b>11</b>
Direct-Mount Installation .....	11
Remote-Mount Installation on Vertical Pipe .....	14
Remote-Mount Installation on Horizontal Pipe .....	15
Field Wiring Connections .....	17
Internal Power Supply .....	18
External Power Supply .....	18
Input Wiring .....	20
Turbine Flowmeter (TFM) Input .....	20
Pulse Input .....	20
Remote Reset Input .....	21
Output Wiring .....	22
Pulse Output .....	22
Analog (4-20 mA) Rate Output .....	22
Flowmeter Frequency Output .....	23
RS-485 Output .....	24
<b>Section 3—Configuration and Operation via Keypad</b> .....	<b>27</b>
Entering a Calibration Factor .....	28
Entering a Calculated Divisor .....	29
Setting Input Type and Sensitivity .....	30
Configuring the Total Display .....	31
Configuring the Rate Display .....	32
Configuring the 4-20 mA Rate Output .....	33
Configuring the Pulse Output .....	36
Entering the Slave Address .....	37
Entering the Baud Rate .....	37

<b>Section 4—Configuration and Operation via Software</b> .....	<b>39</b>
Installing the Software .....	39
Accessing Help.....	39
Connecting to the Software .....	40
Automating Functions on Software Startup .....	41
Changing Autorun Settings .....	42
Express Connect Option .....	42
Changing the Communications Port .....	43
Software Connection in Multi-Device Network.....	43
Setting Log Download Preferences.....	45
Configuring the MC-III WP.....	46
Configuration Wizard .....	48
MC-III Main Screen .....	50
Buttons and Tools.....	51
System Setup .....	54
Time/Date Synchronization .....	54
Contract Hour.....	54
LCD Contrast Adjustment .....	54
Security Setup.....	55
Firmware Version Number .....	55
Serial Number .....	55
Communications Port .....	56
Slave Address .....	56
Baud Rate .....	56
Bus Delay.....	57
Bus Timeout.....	57
Software Communication Options .....	57
Wellsite Information .....	58
Turbine Input .....	59
Volume Display .....	59
Rate Display.....	59
Input Type/Sensitivity Configuration.....	60
Cut-Off Thresholds.....	60
Calculation Period.....	60
K-Factor Entry .....	61
K-Factor Units .....	61
K-Factor Type.....	61
K-Factor Backup .....	62
Gas Volume Correction (Supercompressibility Calculation) .....	63
4-20 mA Output .....	65
Enabling 4-20 mA Output .....	67
4-20 mA Output Testing.....	67
Pulse Output.....	69
Configuring Pulse Output.....	69
Pulse Output Testing.....	70
Saving and Uploading Configuration Files .....	71
Saving a Configuration File.....	71
Uploading a Configuration File.....	72
Advanced Access .....	74
<b>Section 5—Flow Logs and Event Logs</b> .....	<b>75</b>
Auto-Save Log Formats.....	76
Log Directory and Filenames.....	76
Flow Archive .....	77

Downloading Flow Logs .....	77
Viewing Trend Charts .....	79
Printing/Saving a Report .....	79
Viewing a Saved Report .....	81
Exporting Flow Logs .....	83
Event Archive .....	84
Downloading Event Logs .....	85
Printing/Saving a Report .....	86
Exporting Event Logs .....	86
<b>Section 6 - MC-III WP Maintenance .....</b>	<b>89</b>
Lithium Battery Replacement .....	89
Alkaline Battery Replacement .....	90
Circuit Assembly Replacement .....	92
Keypad Replacement .....	94
Firmware Update .....	95
Optional Parts List .....	97
Recommended Magnetic Pickups .....	97
<b>Appendix A—Software Program Options .....</b>	<b>A-1</b>
General Options .....	A-1
Autorun Options .....	A-2
Communications Options .....	A-3
Express Connect Option .....	A-3
Auto-Negotiate Option .....	A-4
Enable Auto-Negotiated Baud Rate Option .....	A-4
Request-to-Send (RTS) Line Option .....	A-4
Enable Modbus Address Support for Firmware Versions 1.06 through 1.08 .....	A-4
Timing Parameters .....	A-4
Downloading Options .....	A-5
Advanced Options .....	A-6
Clear EEPROM .....	A-6
Automatic Data Logging .....	A-6
<b>Appendix B—Lithium Battery Information .....</b>	<b>B-1</b>
Lithium Battery Disposal .....	B-1
Transportation Information .....	B-1
Material Safety Data Sheet .....	B-1
<b>Appendix C—Communications Protocol .....</b>	<b>C-1</b>
Introduction .....	C-1
Supported Commands .....	C-1
Data Types .....	C-1
Registers .....	C-2
System Configuration .....	C-3
Product Code (register 1000) .....	C-4
Firmware/Register Table Version Numbers (registers 1001, 1002) .....	C-4
Manufacture Date/Sales Date (registers 1003, 1004) .....	C-4
Slave Address (register 1009) .....	C-4
Baud Rate (register 1010) .....	C-4
Real Time .....	C-4
Input Configuration .....	C-5
Output Configuration .....	C-8

---

Holding Registers (16-bit Mode) .....	C-9
Holding Registers (16-bit Mode)—Least Significant Word First.....	C-11
Base Units/Configured Units .....	C-11
Conversion Factors .....	C-11
Polling Registers .....	C-12
Pointer/Daily/Event Pointer (registers 17001 through 17006).....	C-12
Real Date (registers 17007, 17008).....	C-12
Real Time (registers 17009, 17010).....	C-12
Totals .....	C-12
Pulse Output Pulses (register 17077).....	C-12
Analog Output Current (register 17079).....	C-12
Calculated K-Factor (register 17081).....	C-12
Control Register .....	C-15
Wellsite Parameters .....	C-15
Log Data .....	C-15
Enron Registers .....	C-16
Enron Hourly/Daily Record Format .....	C-16
Enron Event Record Format .....	C-17
Reset Status .....	C-17
Log Capacity .....	C-17

## Section 1—Introduction

The NuFlo™ MC-III™ WP Flow Analyzer (Figure 1.1) packs a full spectrum of gas and liquid measurement functionality, high-speed performance, and log archive and retrieval capabilities in an easy-to-use weatherproof totalizer. Commonly used operations can be accessed from the six-button keypad on the front of the instrument or from the dynamic interface software, allowing you to calibrate and configure the unit quickly and easily.

### Operation

The MC-III WP calculates and displays instantaneous flow rates and accumulated totals based on a turbine flowmeter input signal. The MC-III's microprocessor circuitry counts the pulses generated by a companion flowmeter, converts that data into volume and rate values in accordance with calibration settings, and displays the totalized data on a two-line liquid crystal display (LCD). The eight-digit top readout indicates total flow volume; the six-digit bottom readout indicates flow rate.

With the press of a single key, totals are saved to nonvolatile memory, minimizing the risk of data loss even if a power outage occurs.

Up to 384 daily logs, 768 hourly logs, and 345 event logs can be archived and accessed quickly on demand.

Offering a variety of user-configurable display options, input and output options, RS-485 Modbus® compatibility, flow logging, and turbine flowmeter linearization, the MC-III WP is one of the most versatile totalizers on the market. For specifications, see [Table 1.1](#), page 2.



Figure 1.1—MC-III WP Flow Analyzer

**Table 1.1—MC-III WP Specifications**

<b>Hazardous Location Certification</b>	CSA-approved for US and Canada Class I, Div. 2, Groups A, B, C, and D Rated for Internal Pollution Degree 2 CSA/UL Type 4 Enclosure (Ingress Protection) T5 Temperature Class
<b>System Power</b>	Internal power supply <ul style="list-style-type: none"> <li>• 3.6 VDC, D-size lithium battery (2-year typical life)</li> <li>• alkaline battery holder containing 3 D-size batteries</li> </ul> External power supply (6 to 30 VDC at 6 mA) with internal battery backup (reverse polarity protected)  Loop-powered (4-20 mA) with internal battery backup (reverse polarity protected) Loop power: 8 to 30 VDC Load resistance: 1100 ohms @ 30 VDC 200 ohms @ 12 VDC
<b>Operating Temperature</b>	Lithium-Powered: -40°C to 70°C (-40°F to 158°F) Alkaline-Powered: -18°C to 55°C (0°F to 130°F) LCD contrast is reduced below -20°C (-4°F)
<b>Environmental</b>	Humidity: 0 to 90% non-condensing Altitude: Up to 2000 m, maximum
<b>Enclosure</b>	Molded fiberglass polyester, Lexan® polycarbonate viewing window 6.91 in. wide × 6.5 in. tall × 4.25 in. deep
<b>LCD Display</b>	8-digit Total (volume) display (7-segment characters) 6-digit Rate display (11-segment characters for easy-to-read prompts) 0.3" character height Adjustable contrast and update period User-selectable units of measurement (Total): <ul style="list-style-type: none"> <li>• Preprogrammed units: BBL, GAL, LIT, M<sup>3</sup>, CF, SCF, any unit x 1000</li> <li>• User-defined units</li> </ul> User-selectable units of measurement (Rate): <ul style="list-style-type: none"> <li>• Preprogrammed units: BBL, GAL, LIT, M<sup>3</sup>, CF, SCF (per DAY, HR, MIN, SEC), any unit x 1000 (per DAY, HR, MIN, SEC)</li> <li>• User-defined units</li> </ul>
<b>Keypad</b>	6-key membrane switch
<b>Communications/Archive Retrieval</b>	RS-485 Modbus® communications with transfer speeds up to 115.2K (allows full download in less than 1 minute)
<b>Logging</b>	384 daily logs 768 hourly logs 345 event logs



**Table 1.1—MC-III WP Specifications**

<b>Inputs</b>	<p>Turbine Meter Input Configurable sensitivity adjustment via front panel Sensitivity adjustment range: 20 mV P-P to 40 mV P-P Frequency range: 0 to 3500 Hz</p> <p>Remote Reset Input Optically-isolated input 3.0 to 30 VDC Pulse duration &gt; 3 seconds to reset</p> <p>Pulse Input Optically-isolated input 3.0 to 30 VDC</p>
<b>Outputs</b>	<p>Analog Output 4-20 mA, loop-powered (two-wire) 16-bit resolution Accuracy: 0.1% of full scale @ 25°C, 50 PPM/°C temperature drift Loop power: 8.0 to 30 VDC Zero and full-scale engineering values configurable from front panel</p> <p>RS-485 Communications Baud rates: 300, 600, 1200, 2400, 4800, 9600, 19200, 38400, 57600 and up to 115.2K</p> <p>Volumetric Pulse Output Solid-state relay Output rating: 60 mA max. @ 30 VDC, on-state drop = 1.4 VDC @ 50 mA, 0.25 VDC @ 10 mA Configurable pulse width (duration): 10 to 60,000 ms</p> <p>Amp &amp; Square (Flowmeter Frequency) Output Open-drain transistor output of turbine meter input signal Output rating: 50 mA @ 30 VDC, on-state drop = 0.3 VDC @ 50 mA, 0.1 VDC @ 10 mA (Analog output and amp &amp; square outputs cannot be used simultaneously.)</p>
<b>Modbus®</b>	RTU mode Modbus® supports 16-bit and 32-bit holding registers. For more information, see <a href="#">Appendix C</a> .
<b>Enron Modbus®</b>	Flow log parameters (time stamp, period total, period run time, and supply voltage) and download method are Enron-compatible.
<b>System Requirements</b>	<p>Operating System - Windows 2000 or later (Windows XP recommended) Computer/Processor - 1 GHz or faster Pentium-compatible CPU Memory - 128 MB of RAM Hard Disk Space - 21 MB for program files, 30 MB for Adobe Reader, adequate space for data files Drive - CD-ROM for install Display - 800 x 600 (SVGA), 16-bit (thousands of colors) color display or greater Browser - Internet Explorer 4 or later Internet Connection - for web links, tech support Communications Port - physical or virtual RS-232 compatible serial port</p>

---

**WARNING**

**EXPLOSION HAZARD—SUBSTITUTION OF COMPONENTS AND/OR THE USE OF EQUIPMENT IN A MANNER OTHER THAN THAT SPECIFIED BY CAMERON MAY IMPAIR SUITABILITY FOR CLASS I, DIVISION 2. CAMERON BEARS NO LEGAL RESPONSIBILITY FOR THE PERFORMANCE OF A PRODUCT THAT HAS BEEN SERVICED OR REPAIRED WITH PARTS THAT ARE NOT AUTHORIZED BY CAMERON.**

**DO NOT DISCONNECT EQUIPMENT UNLESS POWER HAS BEEN SWITCHED OFF OR AREA IS KNOWN TO BE NON-HAZARDOUS.**

**DO NOT OPEN EQUIPMENT UNLESS SIGNAL CIRCUITS AND POWER HAVE BEEN SWITCHED OFF OR AREA IS KNOWN TO BE NON-HAZARDOUS.**

**BATTERIES MUST ONLY BE CHANGED IN AN AREA KNOWN TO BE NON-HAZARDOUS.**

**STATIC HAZARD. DO NOT CLEAN OR RUB ENCLOSURE UNLESS AREA IS KNOWN TO BE NON-HAZARDOUS.**

---

## Key Product Features

This section presents an overview of key features of the MC-III WP. Many of these features are discussed in more detail in [Sections 3](#) and [4](#) (configuration procedures) and [Section 5](#) (flow log archival).

Key features discussed here include:

- LCD display
- keypad
- interface software
- power supply
- calibration options
- input options
- output options
- flow log archival
- password-protected security

### LCD Display

The liquid crystal display ([Figure 1.2](#), page 5) provides a simultaneous indication of accumulated total (top readout) and flow rate (bottom readout). The eight-digit total display uses 7-segment characters to form numbers and letters, which results in a combination of uppercase and lowercase letters. The six-digit flow rate display uses 11-segment characters to form numbers and letters for improved readability. When the keypad is used to calibrate the MC-III WP, the name of the menu option selected appears in the lower (rate) display, and settings are entered in the top (total) display.

Flow volume can be measured in barrels, gallons, liters, cubic meters, cubic feet, standard cubic feet or other user-defined units. A multiplication factor is also available for indicating flow volume in terms of 1,000 units. The unit of measure for the Total readout and the decimal point position are selected by the operator during calibration. If a user-defined unit is used, none of the preprogrammed volume units will be visible on the display during operation.

Flow rate can be measured in a wide variety of preprogrammed units, or other user-defined units. The flow

rate unit of measure is selected in two steps: (1) a volume unit is chosen and (2) a time-base unit (per day, per hour, per minute, or per second) is chosen. Users can choose any combination of preprogrammed volume and time units in establishing the flow rate engineering unit (for example, gallons per hour, gallons per day, or gallons per minute). Also, the volume unit used for the flow rate can be different from the volume unit used to read Total volume. The unit of measure for the Rate readout and the decimal point position are selected by the operator during calibration.

The daily index (Day) display is a two-digit number for selecting a daily archive log for viewing. The number shown here represents the number of days that have passed since the log was saved. For example, an entry of 01 would yield yesterday's log. An entry of 05 would yield the log generated 5 days ago. Up to 99 consecutive daily logs can be viewed using the keypad. In addition, up to 384 daily logs, 768 hourly logs, and 345 event logs can be viewed through the interface software.

The LCD contrast can be adjusted with the interface software (see [Section 4](#)).

## Keypad

The six-button keypad allows users to perform a basic configuration of the instrument. [Figure 1.3](#), page 6, summarizes the functions that can be accessed with each button. Most parameters can be configured in seconds by selecting one of the three menu keys (K-Factor, Output, or Display), navigating settings with the arrow buttons, and saving the selections with the Enter key.

Section 3 contains procedures for configuring the MC-III WP using the keypad. Icons of the six buttons provide a pictorial reference to help guide users through each step of configuration.

---

**Important:** Some configuration parameters are accessible only through the interface software. See [Section 4](#) for instructions on configuring the instrument using the software.

---

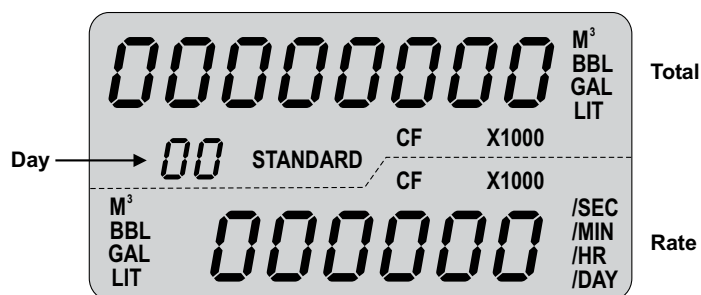

Figure 1.2—LCD display showing location of the Total, Rate, and daily index (Day) displays. Only the units of measurement selected for displaying total and rate will be visible during normal operation.

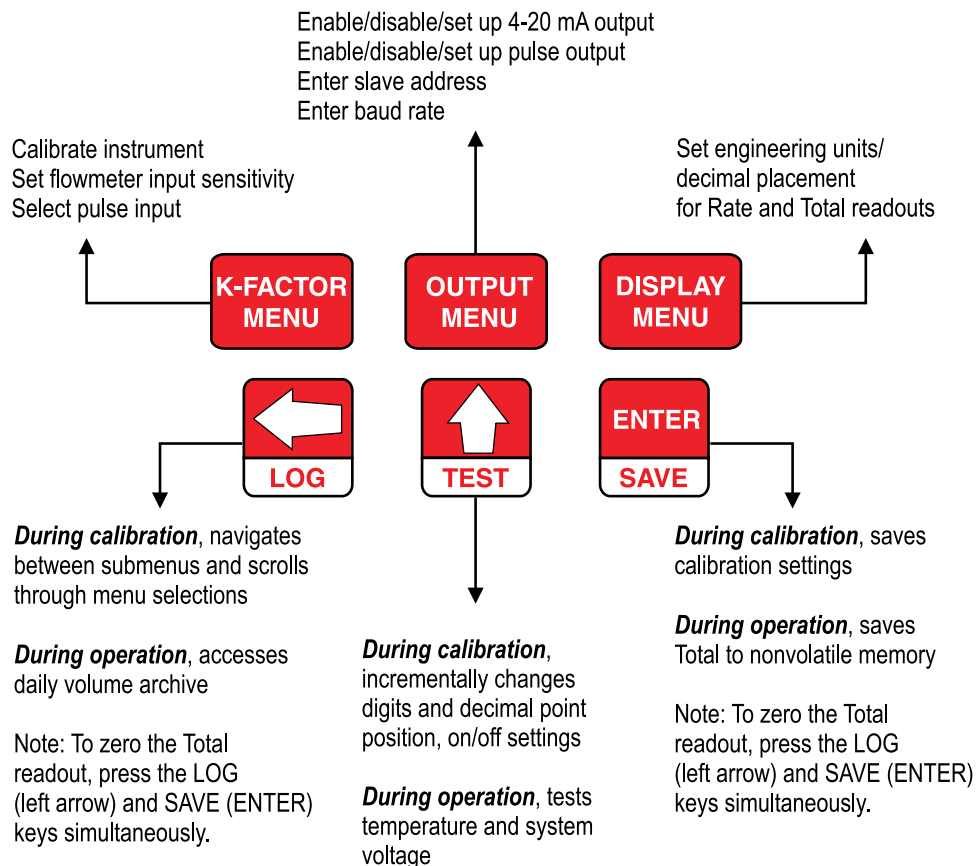

Figure 1.3—MC-III WP keypad functions

## Interface Software

Developed within the familiar Windows environment, the MC-III interface software is an intuitive and easy-to-use application that provides access to all controls for setting up and operating the instrument. The interface tailors the controls to the user's needs, providing three options for configuring the instrument:

- a “Configuration Wizard,” which steps through the most common configuration tasks
- individual configuration menus for accessing specific settings
- an advanced menu that gives host programmers access to Modbus® registers

For instructions on installing the interface software and entering configuration parameters via the interface software, see [Section 4](#).

## Power Supply

The MC-III WP is shipped with either a lithium battery or a battery holder containing three D-size alkaline batteries. Alternately, the MC-III WP may be powered by an external power source; in this case, the lithium battery or alkaline batteries provide a backup power supply, significantly extending battery service life. Low-power microprocessor technology enables the MC-III WP to operate approximately 2 years on a single lithium battery.

**External Power Supply.** The device will automatically switch to battery power when external power is lost. The external power supply must be an approved ELV source, insulated from the AC main by double/reinforced insulation per CSA C22.2 No. 61010-1-04 / UL61010-1 – 2nd Edition.

Wiring diagrams for connecting an external power supply are provided in [Section 2](#).

## Multipoint Linearization

The MC-III interface software supports up to 12 calibration points in addition to single-point calibration based on the K-factor provided with the turbine flowmeter. See *K-Factor Type*, page 61, for more information.

## Gas Volume Correction

Gas turbine meters are calibrated in actual cubic feet (ACF), and measure gas in actual cubic feet. In some applications, a user may benefit from referencing gas measurements back to standard conditions by measuring in terms of standard cubic feet (SCF). The MC-III WP makes this process quick and easy, by using fixed average values for the flowing gas temperature and flowing gas pressure. See *Gas Volume Correction*, page 63, for more information.

## Input Options

The flowmeter signal can be obtained from a magnetic pickup or a pre-amplifier device. The sensitivity of the flowmeter input may be adjusted with the instrument keypad or the interface software. See *Section 2* for wiring diagrams. See *Sections 3* and *4* for configuration procedures.

## Output Options

The MC-III WP standard circuitry provides:

- a scaled pulse output representing an increment in volume for each pulse
- a loop-powered 4-20 mA output representing the flow rate
- a flowmeter frequency output for use with remote equipment to derive flow rate and volume
- an RS-485 output for communication with interface software or other telemetry equipment

When the 4-20 mA rate output feature is used, the MC-III WP is powered by the current loop, and the lithium battery or alkaline batteries are used as a backup supply.

The pulse output and 4-20 mA output features should be turned off when not required for reduced current consumption. See *Section 2* for wiring diagrams. See *Sections 3* and *4* for configuration procedures.

## Flow Log Archival

The MC-III WP saves up to 384 daily logs and 768 hourly logs in nonvolatile memory. By connecting with the interface software, users can download the logs for viewing and/or printing in tabular format or in a trend chart.

Users can also export daily and hourly logs to a spreadsheet. For more information, see *Section 5*.

## Event Log Archival

The MC-III WP saves up to 345 user event logs. Event logs are generated to track user changes such as K-factor changes, input setting changes, power-on reset and “watch-dog” reset, flow cut-off and frequency cut-off.

By connecting with the interface software, users can download the logs for viewing and/or printing in tabular format. In addition to showing old and new values, each event log is time-stamped, and includes the register associated with the change. For more information, see *Section 5*.

## Password-Protected Security

A keypad security access code prevents unauthorized personnel from altering the calibration or accumulated volume data in the instrument. The security feature may be disabled if this protection is not required.

Password-protected security access is enabled using the interface software. When this feature is enabled, the user will be prompted for a password when attempting to enter any menu from the keypad. For more information, see [Security Setup](#), page 55.

## Commonly Used Functions

While the functions of the MC-III WP are too numerous to mention, some of the most commonly used functions are detailed in this section. They include:

- reading the rate and accumulated total
- saving totals to memory
- resetting the total
- viewing daily and hourly logs
- saving and uploading configuration files
- exporting log data to spreadsheet
- saving log data in a report

### Reading Totals

Current totals can be viewed from the LCD on the front of the MC-III WP or from the interface software (MC-III Main screen). The software calculates the flow total and updates the LCD display every 4 seconds, by default. The user can adjust the calculation period with the interface software. See [Calculation Period](#), page 60, for more information.

### Saving Totals to Memory

Hourly and daily totals are automatically saved to nonvolatile memory. A user may also save an accumulated total at any time by opening the enclosure and pressing ENTER (SAVE) on the keypad. In the event of a power failure, the last saved total will be displayed on the LCD when power is restored.

---

**Important:** Always save the accumulated total before replacing batteries.

---

### Resetting the Total

Totals can be reset to zero using the keypad, the interface software, or a pulse from an external device.

- To reset the total with the keypad, press LEFT ARROW (LOG) and ENTER (SAVE) keys simultaneously.
- To reset the total with the interface software, double-click the MC-III icon on the computer desktop and wait for the software to connect to the instrument; then select MC-III Main from the Device Autorun Options screen, and click on the “Reset Flow Total” button in the lower right corner of the Main screen.

### Viewing Daily and Hourly Logs

Each day, as the user-defined contract hour passes, a daily flow total is saved to nonvolatile memory. Hourly logs are also automatically saved. A total of 384 daily logs and 768 hourly logs are accessible for viewing and exporting using the interface software. See [Section 5](#) for details.

Up to 99 daily flow log totals can be viewed from the LCD. Hourly flow log totals are accessible only through the interface software.

To view daily flow totals from the LCD, perform the following steps:

1. Press the LEFT ARROW (LOG) key on the keypad. The words “Daily Volume Archive” will scroll across the bottom of the LCD and the day index will display “01.” The daily flow total recorded at the last contract hour will appear at the top of the LCD.

The index number represents the number of days previous to the current date. For example, yesterday’s totals are read by entering an index of “01”; totals from two days previous are read by entering “02.”

2. Press UP ARROW (TEST) to increment the index (01, 02, 03...); press LEFT ARROW (LOG) to decrement the index (01, 99, 98...).
3. Press Enter (Save) to exit the Daily Volume Archive menu. (After 2 minutes of inactivity, the Daily Volume Archive menu will time out and the total readout will be restored automatically.)

### **Saving and Uploading Configuration Files**

The MC-III interface software allows users to save an unlimited number of configuration files to their computer. In the event that a configuration setting gets changed unintentionally or a user simply wants to restore the settings he used previously, the user can upload the configuration file and resume operation within minutes. The upload function also allows a configuration file to be loaded quickly into multiple devices. The default directory for saving configuration files is C:\NuFlo log data\MC-III. However, MC-III WP users can specify a different location, if desired.

For complete information, see [Saving and Uploading Configuration Files](#), page 71.

### **Exporting Log Data**

Flow logs and event logs can be directly exported to an .xls or .csv file. For complete information, see [Exporting Flow Logs](#), page 83, and [Exporting Event Logs](#), page 86. The default directory for exported logs is C:\NuFlo log data\MC-III. However, MC-III WP users can specify a different location, if desired.

### **Saving Log Data in a Report**

Flow logs can be saved in a report format that can be loaded back into the software for viewing or printing at a later time. For complete information, see [Printing/Saving a Report](#), page 79. The default directory for log reports is C:\NuFlo log data\MC-III\<WELL NAME>. However, MC-III WP users can specify a different location, if desired.





## Section 2—Installation

The MC-III™ WP is fully assembled at the time of shipment and ready for mounting to a flowmeter. Instruments for direct-mount installation include an enclosure attached to a threaded mount (*Figure 2.1*, page 12). Remote-mount instruments come with mounting brackets and bolts for attaching the instrument to a vertical or horizontal pipe.

The MC-III™ WP is CSA-approved for Class I, Div. 2, Groups A, B, C, and D for use in hazardous locations.

---

**Important:** Before installing the MC-III™ WP, read the Important Safety Information section on the inside cover of this manual.

---

### Preparation

Before attempting to install the MC-III WP, make sure the flowmeter and magnetic pickup are installed as follows:

1. Install the turbine flowmeter in the flow line.
2. Lightly grease the threads on both ends of the magnetic pickup, taking care to keep grease off of the connector contacts. If the connector is plastic, apply grease only to the end that threads into the meter.
3. Install the magnetic pickup in the flowmeter.
4. After the flowmeter and magnetic pickup are installed in the flow line, mount the MC-III WP flow analyzer as described below.

### Direct-Mount Installation

To install the MC-III WP on a turbine flowmeter, perform the following steps. Dimensions are provided in *Figure 2.2*, page 13.

1. Position the MC-III WP above the flowmeter.
2. Plug the MC-III WP cable connector into the magnetic pickup and hand-tighten the knurled nut on the connector.
3. Screw the MC-III WP mount onto the flowmeter threads surrounding the magnetic pickup.
4. With the display facing the desired direction, tighten the two screws on either side of the mount to prevent horizontal shifting.

With the display oriented vertically in the desired direction, tighten the two hex-head bolts on either side of the top section of the mount to prevent vertical shifting.

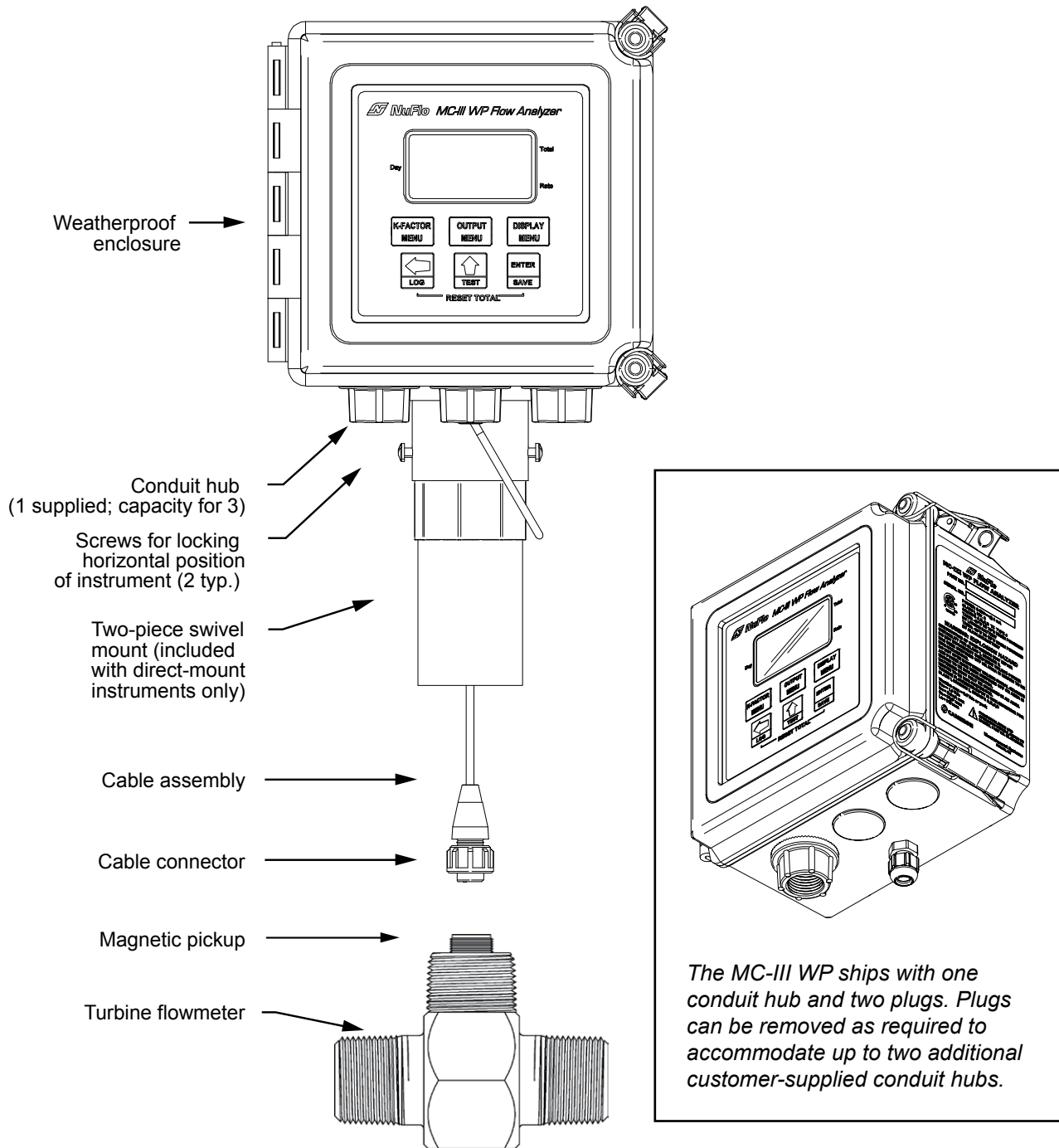

Figure 2.1—MC-III WP to flowmeter connection

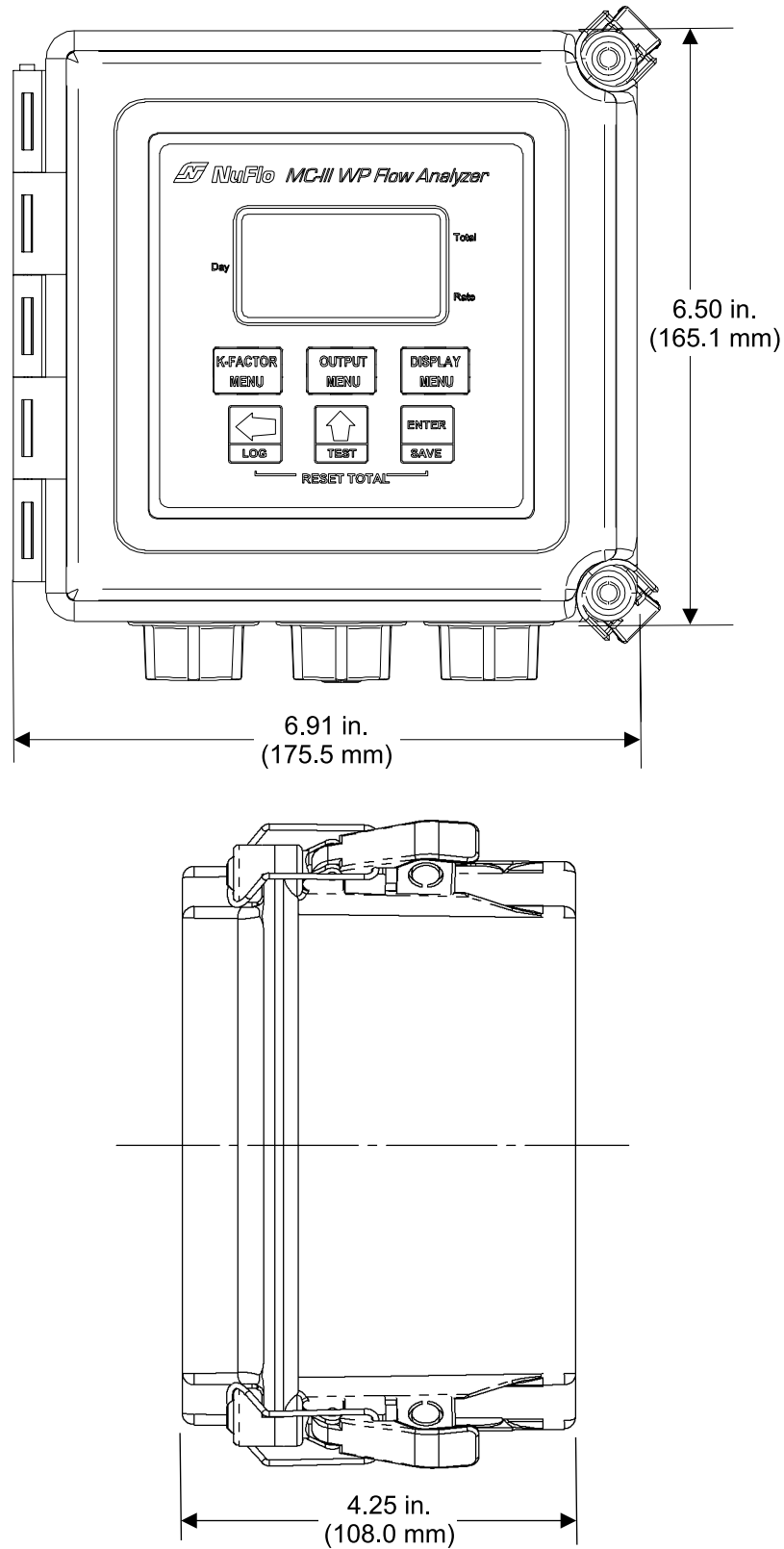

Figure 2.2—Typical mount dimensions in inches (millimeters) for direct-mount installation

## Remote-Mount Installation on Vertical Pipe

The remote-mount MC-III WP Flow Analyzer is assembled at the factory for mounting on a vertical pipe. To install the MC-III WP on a vertical pipe, perform the following steps. Dimensions are provided in Figure 2.3.

1. Place the “U” bolts around the vertical pipe section and through the mounting plate.
2. Fasten the mounting plate with the lock washers and nuts supplied with the “U” bolts.
3. Install the signal cable through the rear cable connector at the bottom of the enclosure.
4. Route the cable to the flowmeter and install as shown in the flowmeter user manual.

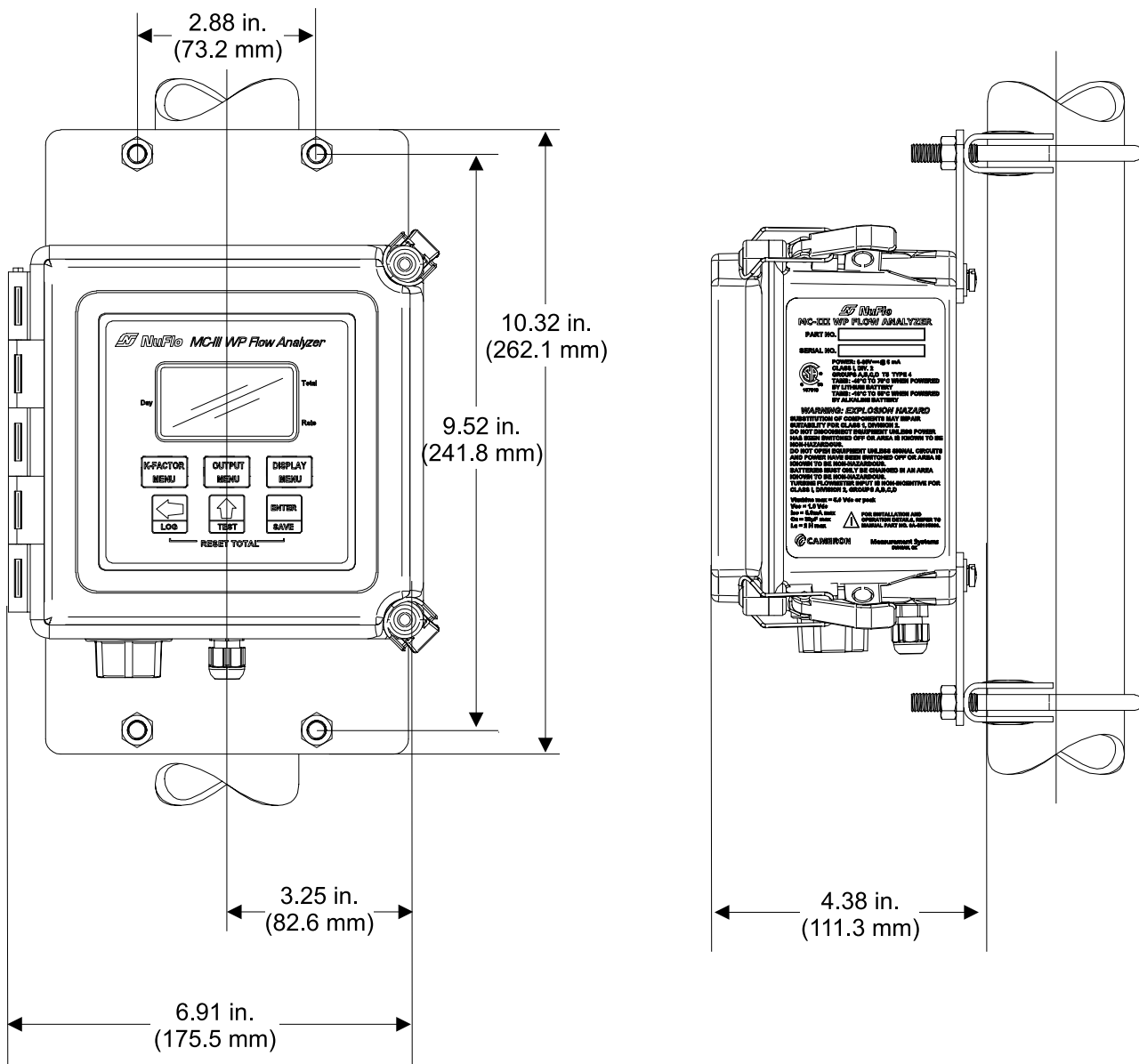

Figure 2.3—Typical mount dimensions in inches (millimeters) for remote-mount installation on vertical pipe

## Remote-Mount Installation on Horizontal Pipe

The remote-mount MC-III WP Flow Analyzer is assembled at the factory for mounting on a vertical pipe. To install the MC-III WP on a horizontal pipe, the brackets must be removed and reattached in a different position. To make the adjustment, perform the following steps. Dimensions are provided in *Figure 2.5, page 16*.

1. Place the enclosure on its face and remove the four screws securing the brackets. Remove the brackets and set aside the eight spacer flat washers (two at each screw hole). Retain the screws and washers for use in steps 2 and 3. Note the two sets of mounting holes in the bracket. The screws are positioned in the holes nearest the center of the bracket (as appropriate for vertical mounting) when the instrument leaves the factory (Figure 2.4).
2. Dry-fit the brackets with the mounting holes in the enclosure so that a bracket extends to the right and left of the enclosure (as opposed to top and bottom). Using the washers that were removed in step 1, place two washers inside each screw hole inset in the enclosure and position the brackets on top of the washers so that the enclosure screw holes align with the *outer* holes of the bracket.
3. Insert the screws that were removed in step 1 in the *outer* holes of the bracket and tighten with a screwdriver (Figure 2.4).
4. Place the “U” bolts around the horizontal pipe section and through the mounting plate.
5. Fasten the mounting plate with the lock washers and nuts supplied with the “U” bolts.
6. Install the signal cable through the rear cable connector at the bottom of the enclosure.
7. Route the cable to the flowmeter and install as shown in the flowmeter user manual.

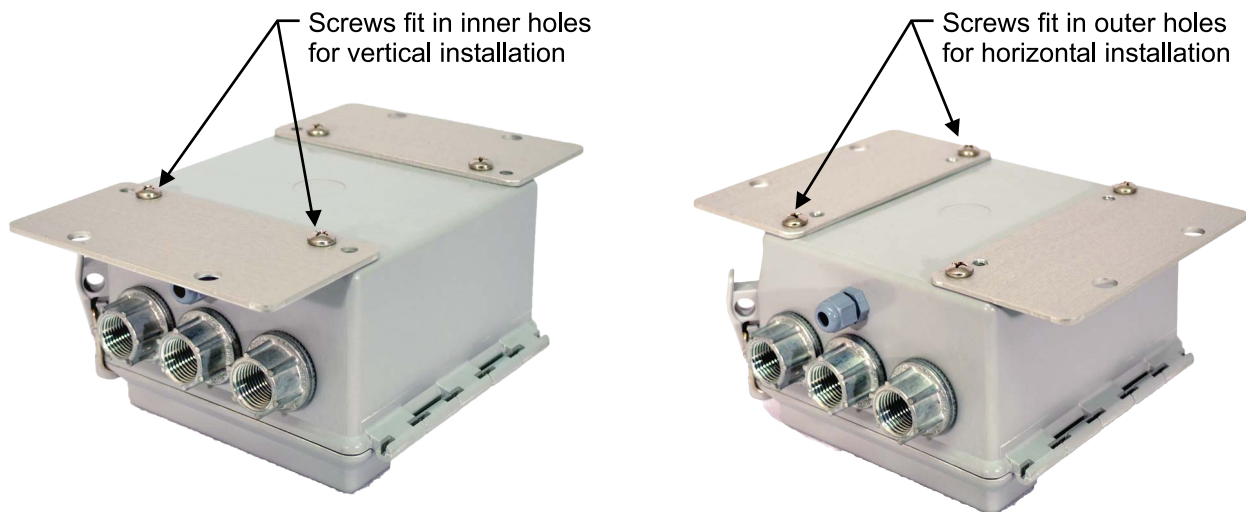

Figure 2.4—Conversion of brackets for mounting instrument to horizontal pipe

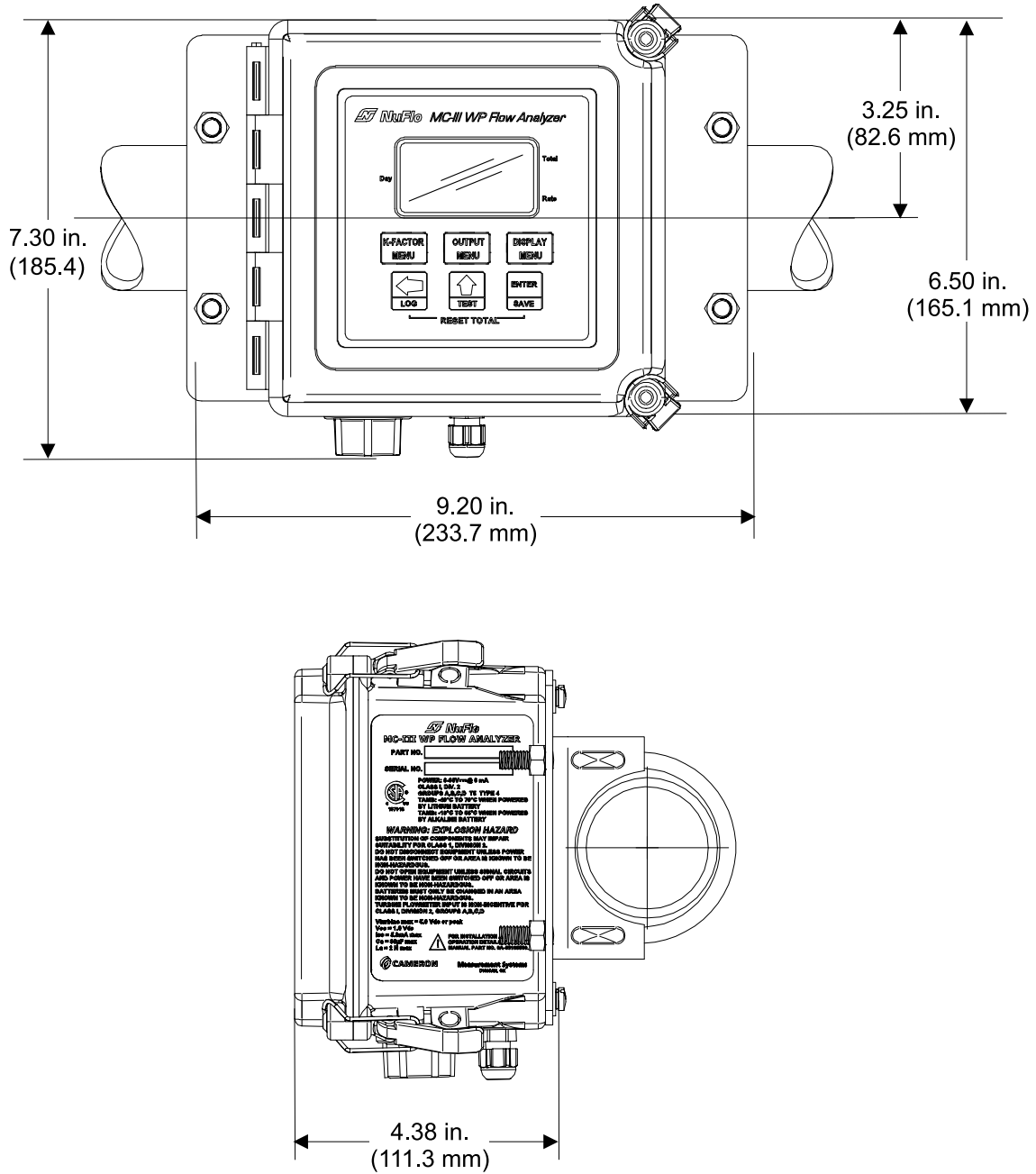

Figure 2.5—Typical mount dimensions in inches (millimeters) for remote-mount installation on horizontal pipe

## Field Wiring Connections

All field wiring enters the MC-III WP through the bottom of the enclosure and connects to the circuit assembly inside the enclosure door. Wiring is routed through up to three conduit hubs (one hub is provided with the unit and two additional entrances are plugged but available for use with customer-supplied hubs). A rear cord connector is used for the magnetic pickup from the turbine meter.

### Hazardous Area Precautions

---

WARNING



**Do not attempt to install the battery or connect field wiring unless the area has been de-classified or is known to be non-hazardous.**

---

### Wiring Procedure

---

**Caution:** All field wiring must conform to the National Electric Code, NFPA 70, Article 501-4(b) for installations within the United States or as specified in Section 18-156 of the Canadian Electrical Code for installations within Canada. Local wiring ordinances may also apply. All field wiring must have a wire range of 22 to 14 AWG and terminal block screws must be tightened to a minimum torque of 5 to 7 in-lbs. to secure the wiring within the terminal block. Only personnel who are experienced with field wiring should perform these procedures.

**The instrument must be grounded with a protective earth grounding conductor in accordance with national and local electrical codes. See step 3 of the wiring procedure below.**

---

To wire the MC-III WP for operation, complete the following field connections:

1. Unlatch the door of the enclosure to access the circuit assembly mounted inside the door.
2. Connect the lithium battery or alkaline battery holder to the J1 connector on the circuit assembly.
3. Connect a ground wire to the internal ground connection screw located inside the enclosure. The screw is identified with the ground symbol, as shown in [Figure 2.6, page 18](#). For DC-powered installations, route the protective earth grounding conductor into the enclosure with the incoming power conductors.
4. Connect wiring for external power, if appropriate. See [Figure 2.7, page 19](#).
5. Connect the flowmeter or pulse input wiring to terminal block TB1. See [Figure 2.8 and 2.9, page 20](#).
6. Connect wiring for the remote reset input to terminal block TB1, if appropriate. See [Figure 2.10 and 2.11, page 21](#).
7. Connect wiring for output signals, if appropriate. See [Figure 2.12 through 2.17, pages page 22 through page 25](#).
8. Recalibrate the MC-III WP (if necessary).
9. If external and internal power supplies were removed, reset the clock to ensure that the time stamps in the log data are accurate. The clock is reset using the MC-III interface software. See [Time/Date Synchronization, page 54](#).
10. Replace the enclosure cover by threading it onto the enclosure in a clockwise direction.

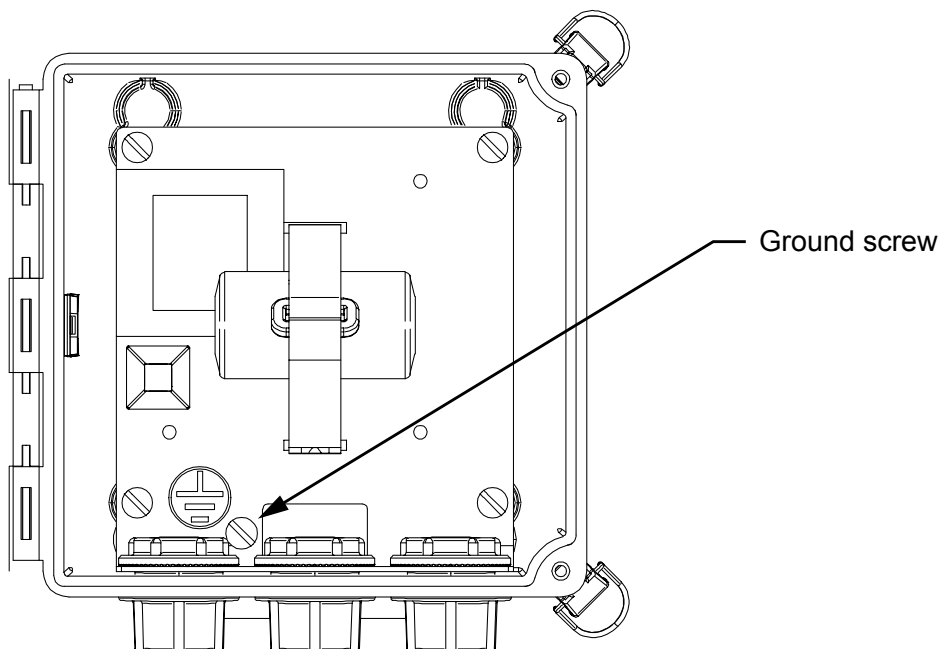

Figure 2.6—Ground connection screw (enclosure shown with door removed)

## Power Supply Wiring

### Internal Power Supply

The MC-III WP is shipped with either of two internal power supplies:

- a 3.6-V lithium battery
- alkaline battery holder containing three D-size batteries

Low-power microprocessor technology enables the MC-III WP analyzer to operate approximately 2 years on a single lithium battery. The lithium battery is strongly recommended for use in extreme temperatures (below  $-20^{\circ}\text{C}$ ).

Users can power the instrument from an external power supply or a 4-20 mA current loop, and use the lithium or alkaline battery as a backup power supply. The use of an alternate power source extends battery life and helps ensure that timekeeping and volume accumulation will not be interrupted during a power failure.

### External Power Supply

The MC-III WP can be connected to a remote power supply by a two-conductor cable ([Figure 2.7, page 19](#)). The power supply and cable must be capable of supplying 6 to 30 VDC @ 10 mA. This capability is available only if the 4-20 mA rate output is not used.

**External Power Supply.** The device will automatically switch to battery power when external power is lost. The external power supply must be an approved ELV source, insulated from the AC main by double/reinforced insulation per CSA C22.2 No. 61010-1-04 / UL61010-1 – 2nd Edition.



**Important:** In all applications using an external DC power supply, a protective over-current device rated at a 0.5A maximum (such as a circuit breaker or fuse) must be connected to the positive supply line of the DC power supply in the safe area. A recommended protective device is a 0.5-A ceramic fuse, such as the Bussman GDS-500mA or the Littelfuse 216.500.

A disconnect switch must also be included in the safe area within easy reach of the operator, and clearly marked as the “disconnect” for the safe area external DC power supply.

**Caution:** The instrument must be grounded with a protective earth grounding conductor in accordance with national and local electrical codes. To ground the instrument, connect a ground wire to the internal ground connection screw located inside the enclosure (Figure 2.7). For DC-powered installations, route the protective earth grounding conductor into the enclosure with the incoming power conductors.

**Caution:** When using the amp & square output with the external power supply, make sure the power supplies for both features share a common negative (-) terminal or that they are totally isolated from each other, since both share a common negative (-) connection.

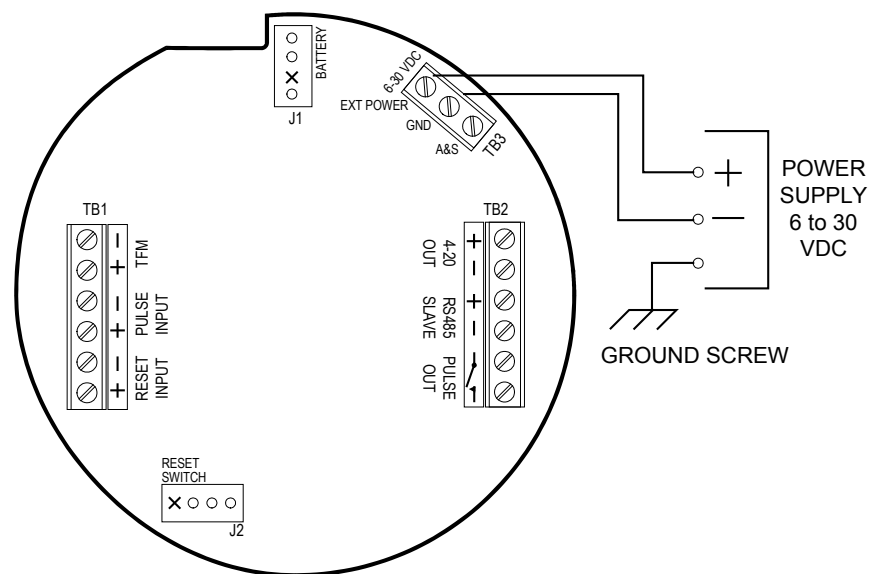

Figure 2.7—External power supply wiring

# Input Wiring

**WARNING**



If installing the MC-III WP in a hazardous area, do not attempt to install input wiring unless the area has been declassified or is known to be non-hazardous.

## Turbine Flowmeter (TFM) Input

The TFM input provides the turbine flowmeter input signal generated by a magnetic pickup, enabling the MC-III WP to calculate and display instantaneous flow rates and accumulated totals.

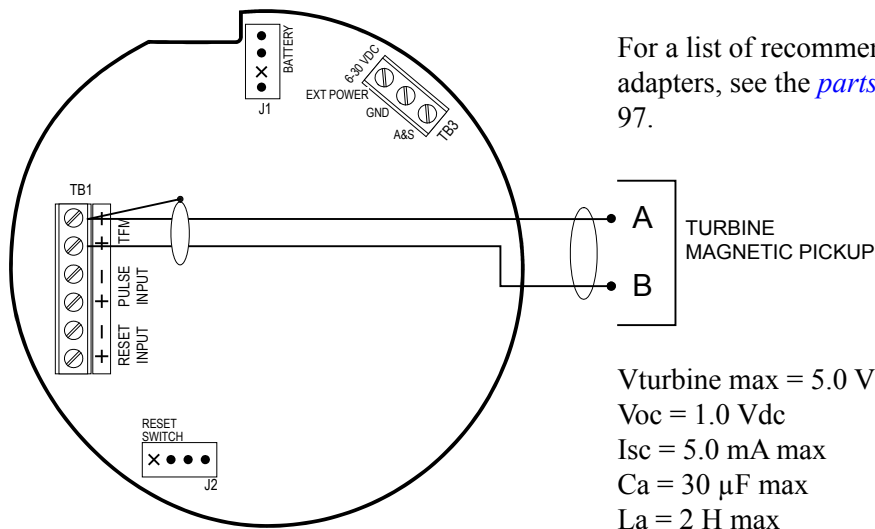

Figure 2.8—Flowmeter input wiring

## Pulse Input

The pulse input provides an optically isolated input in systems where a preamplifier is inserted between the sensor and the MC-III WP.

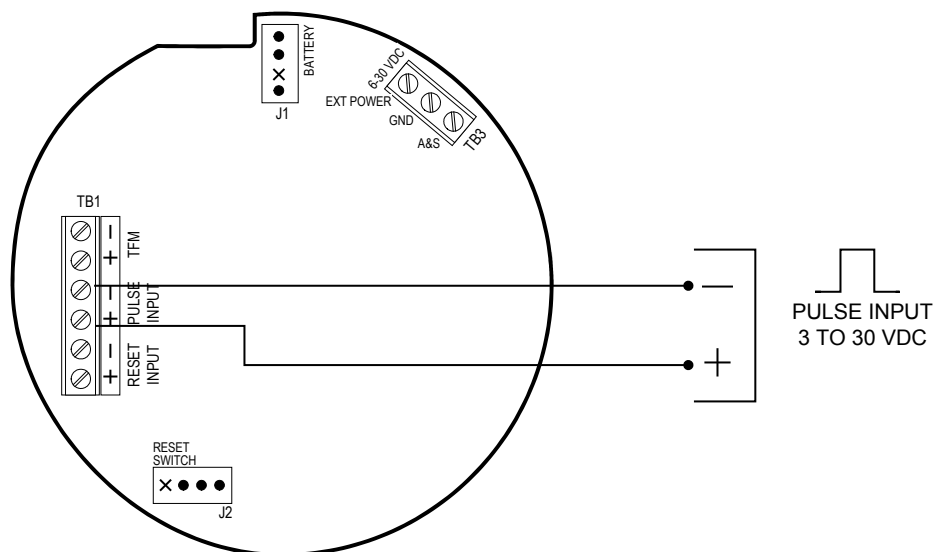

Figure 2.9—Pulse input wiring

### Remote Reset Input

The remote reset input allows the operator to reset the accumulated volume on the MC-III WP to zero without opening the enclosure. This input is optically isolated. The input is shown connected in two ways, with a power supply and switch in a remote location (Figure 2.10), and with a pulse generator in a remote location (Figure 2.11).

The reset input or reset pulse must be active for 3 seconds to clear the total.

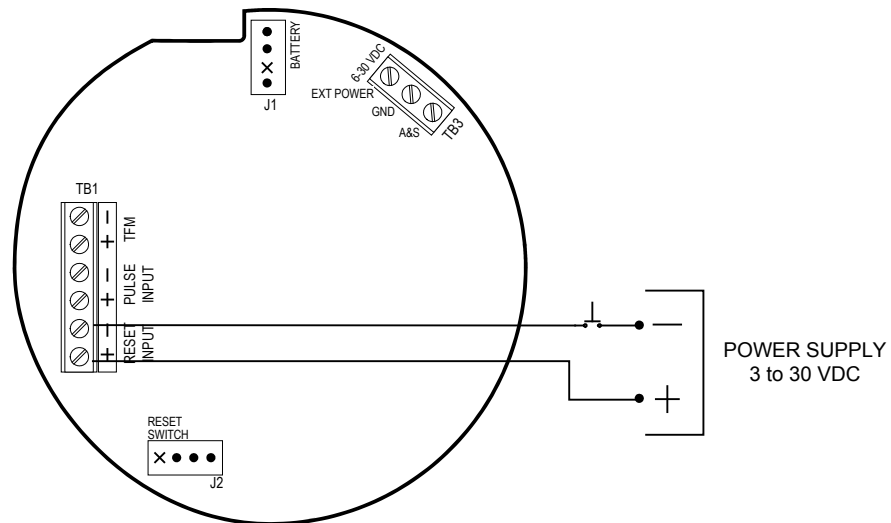

Figure 2.10—Reset input wiring (switch/power supply)

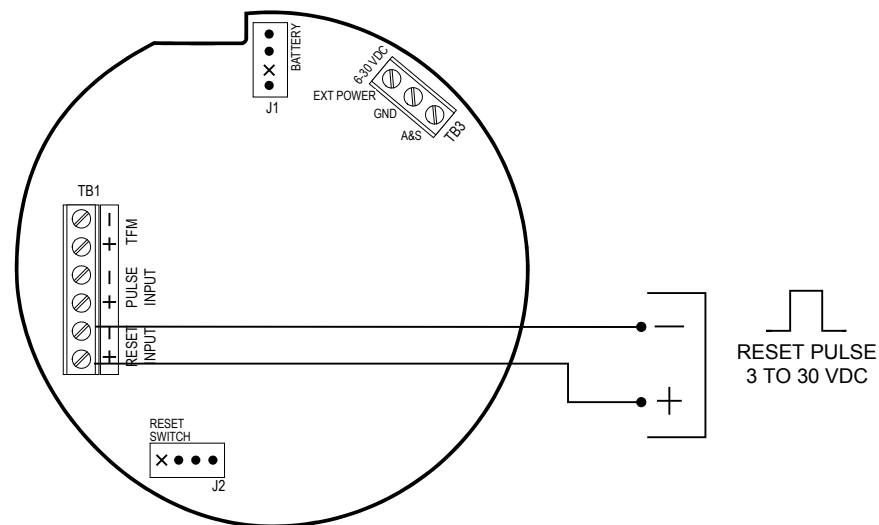

Figure 2.11—Reset input wiring (pulse)

## Output Wiring

**WARNING**

If installing the MC-III WP in a hazardous area, do not attempt to install output wiring unless the area has been declassified or is known to be non-hazardous.

The MC-III WP supports four outputs: pulse output, 4 to 20 mA output, flowmeter frequency (amp & square) output, and RS-485 output. Wiring diagrams for each feature are provided below.

### Pulse Output

The pulse output is a solid-state relay. Each pulse represents a user-defined volume. Because the circuit is isolated, it can be used in conjunction with any other feature on the MC-III WP. A two-conductor cable from the MC-III WP to the remote location is required. The maximum current rating of the pulse output circuit is 60 mA at 30 VDC.

For information on configuring the pulse output with the keypad, see [page 36](#). For information on configuring the pulse output with the interface software, see [page 69](#).

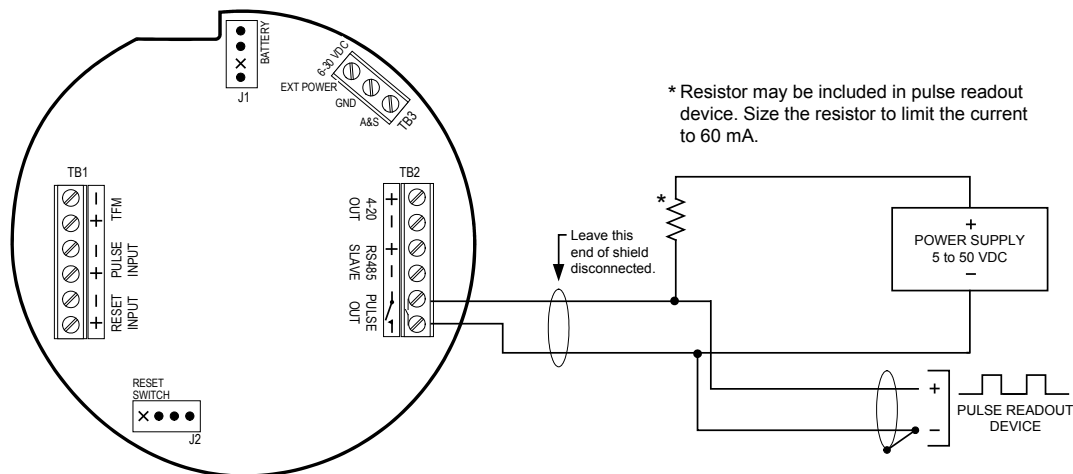

Figure 2.12—Pulse output wiring

### Analog (4-20 mA) Rate Output

The 4-20 mA rate output provides a linear current output that represents flow rate. This output requires a two-conductor cable connected to an 8 to 30 VDC power supply (voltage required is dependent on loop resistance) and a current readout device located in the remote location. The 4-20 mA rate output current loop also powers the MC-III WP. The internal battery (lithium or alkaline) provides a power supply backup to maintain timekeeping accuracy and to continue accumulating volume in the event that the 4-20 mA current loop fails.

[Figure 2.13, page 23](#), shows the minimum required voltage to power the instrument for a given loop resistance. In addition, the mathematical relationship between loop voltage and load resistance is given. For example, if a power supply voltage of 24 volts is available to power the current loop, the maximum load resistance would be 800 ohms.

**Caution:** The 4-20 mA rate output and the flowmeter frequency output circuits are not isolated from each other and cannot be used simultaneously. When the 4-20 mA output option is used, do not connect external power to TB3.

For information on configuring the 4-20 mA rate output with the keypad, see [page 33](#). For information on configuring the 4-20 mA rate output with the interface software, see [page 65](#).

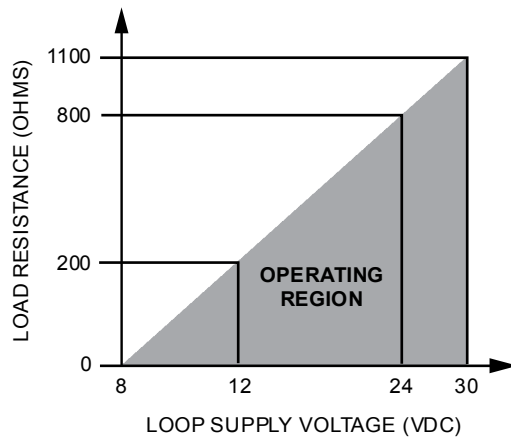
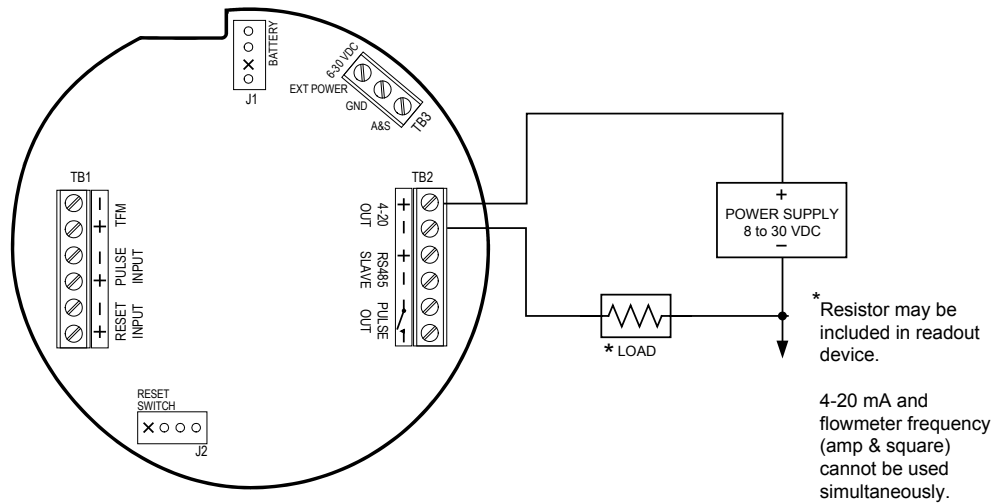

$$R_L \text{ MAX} = \frac{(V \text{ loop} - 8V)}{20 \text{ mA}}$$

$$R_L \text{ MAX} = \frac{(24V \text{ loop} - 8V)}{20 \text{ mA}}$$

$$R_L \text{ MAX} = 800 \text{ ohms}$$

Figure 2.13—4-20 mA rate output wiring

### Flowmeter Frequency Output

The flowmeter frequency (amp & square) output provides an open drain transistor output at the turbine meter frequency, which may be used to provide flow rate and/or total information to peripheral equipment. The output requires a two-conductor cable from the MC-III WP to the remote frequency readout device requiring 50 mA or less and a 5 to 30 VDC power supply ([Figure 2.14, page 24](#)).

---

**Caution:** The flowmeter frequency output and 4-20 mA rate output are not isolated from each other and cannot be used simultaneously.

---



---

**Caution:** When using the flowmeter frequency output and powering the device from an external power supply, make sure both power supplies share a common negative (-) terminal or are totally isolated from each other.

---

The flowmeter frequency output terminals on the MC-III WP circuit assembly are labeled A & S to represent “amp & square” output.

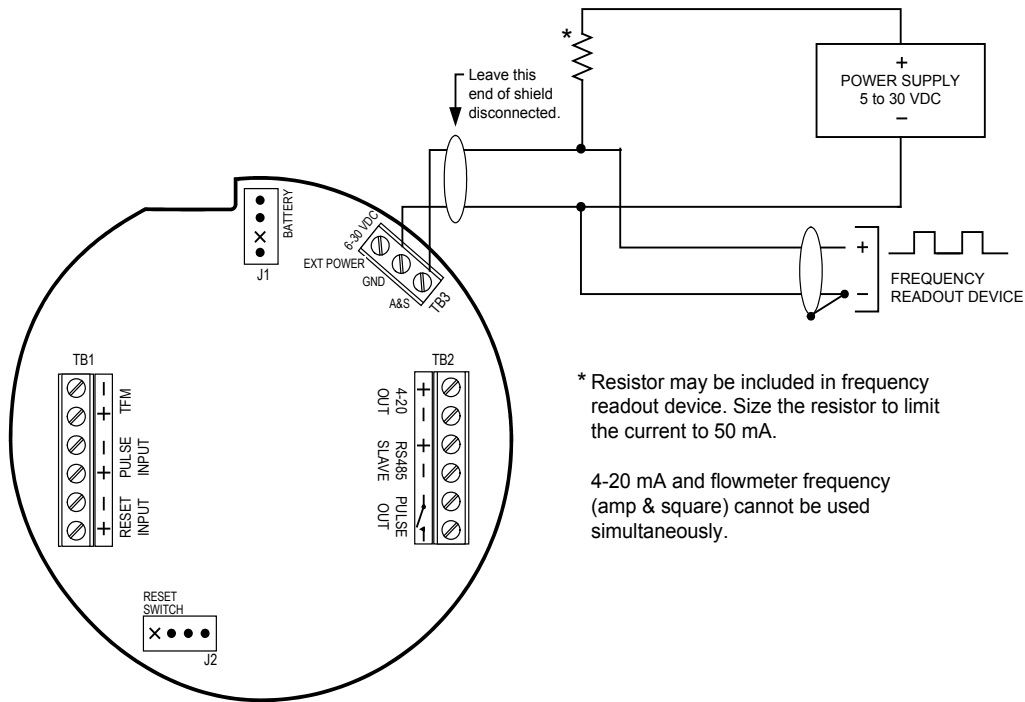

Figure 2.14—Flowmeter frequency (amp & square) output wiring

### RS-485 Output

The RS-485 output is required for communication with the interface software. Wiring diagrams are provided for a permanent connection (Figure 2.16), as well as for temporary laptop connections using an RS-485 to RS-232 converter (Figure 2.16 and 2.17, page 25).

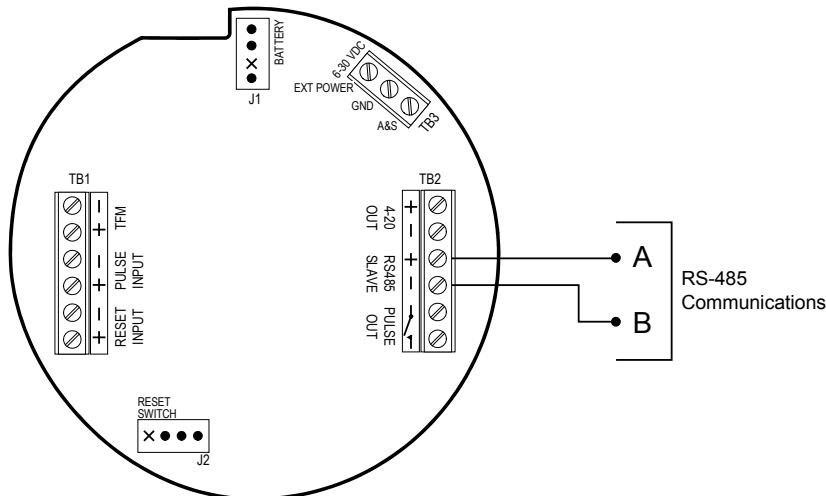

Figure 2.15—RS-485 output (permanent connection)

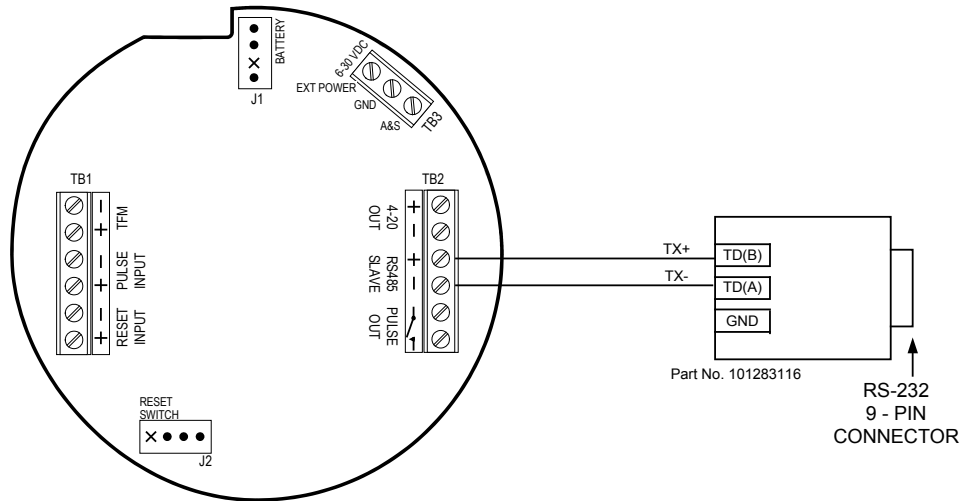

Figure 2.16—RS-485 output (connection to laptop with 9-pin converter)

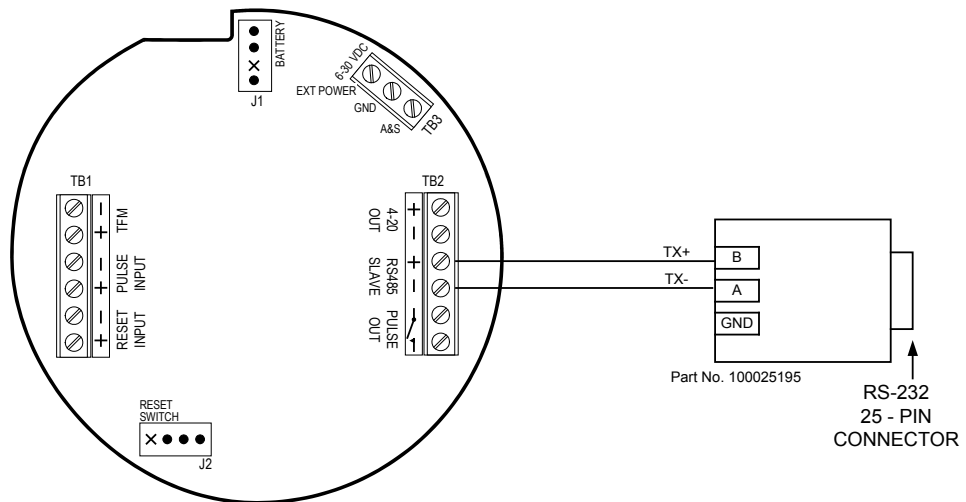

Figure 2.17—RS-485 output (connection to laptop with 25-pin converter)





## Section 3—Configuration and Operation via Keypad

Calibration of the MC-III™ WP is a simple matter of entering necessary parameters into the instrument.

The process for calibrating the MC-III WP depends on how the instrument will be used. The keypad can be used to calibrate the MC-III WP for liquid or gas measurement using preprogrammed units, or for liquid measurement using a calculated divisor. When preprogrammed units are used, the MC-III WP automatically calculates the divisor for volume calculation and the rate multiplier for flow rate calculation, making calibration quick and easy.

---

**Important:** For compensated gas measurement, or gas or liquid measurement requiring multipoint (2- to 12-point) linearization, calibration must be performed with the software user interface (see [Section 4](#)).

---

The following parameters can be configured using the six-button keypad on the front of the instrument:









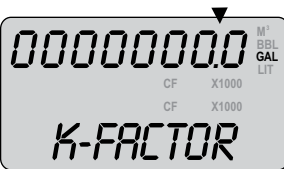

- calibration factor and unit
- units of measurement for Total and Rate displays
- decimal position for Total and Rate displays
- input type and sensitivity level
- 4-20 mA output
- pulse output scale factor
- slave address
- baud rate

## Entering a Calibration Factor

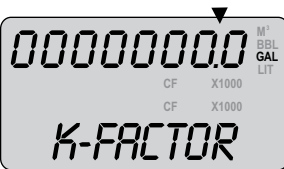
When the volume is to be expressed in barrels (BBL), gallons (GAL), liters (LIT), cubic meters (M<sup>3</sup>), or cubic feet (CF), and the flow rate is to be expressed in barrels, gallons, liters, cubic meters or cubic feet per day, per hour, per minute, or per second, the MC-III WP calculates the divisor automatically; only the turbine meter calibration factor is required.

When the volume is to be expressed in a unit other than the preprogrammed units listed above, a calculated divisor must be entered at the K-Factor prompt. See [Entering a Calculated Divisor](#), page 29.

### To Enter a Calibration Factor:

Enter the K-Factor menu.	Press K-FACTOR MENU.		
Select the unit of measure associated with the calibration factor (typically, pulses per gallon).	Press UP ARROW until the correct unit is displayed.		
Enter the decimal point position for the calibration factor.	Press LEFT ARROW to select the decimal point.		
	Press UP ARROW to change the position of the decimal point.		
	Press LEFT ARROW to save the decimal point position and proceed with entering a calibration factor.		
Enter the calibration factor, starting with the last digit and entering digits right to left.	Press UP ARROW until the last digit of the calibration factor is displayed.		
	Press LEFT ARROW to select the next digit to the left.		
	Repeat using UP and LEFT arrows to enter all remaining digits.		
	Press ENTER.		

The Input Sensitivity menu will appear following the entry of the calibration factor. See [Setting Input Type and Sensitivity](#), page 30, for the input sensitivity configuration procedure.

## Entering a Calculated Divisor

When registering the volume in units other than cubic meters, cubic feet, barrels, gallons, or liters, a calculated divisor must be entered in the K-Factor menu instead of the turbine meter calibration factor.

---

**Important:** When a calculated divisor is used, the units for both the volume display and the volume portion of the flow rate display should be set to USER (no units visible on the display).

---

The divisor and divisor decimal point must be determined, then entered in the K-Factor menu.

The formula for calculating the divisor is:

$$Divisor = FC \times CON$$

Where:

FC = meter factor in pulses per gallon (P/G)

CON = the conversion factor for number of gallons per unit volume of desired measure

### To Enter a Calculated Divisor:

Enter the K-Factor menu.

Press K-FACTOR MENU.



Select no unit of measure.

Press UP ARROW until no unit is displayed (as shown).

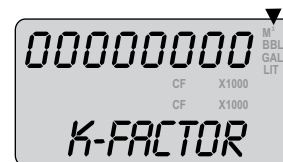

Enter the decimal point position for the calculated divisor.

Press LEFT ARROW to select the decimal point.



Press UP ARROW to change the position of the decimal point.



Press LEFT ARROW to save the decimal point position and proceed with entering a calculated divisor.

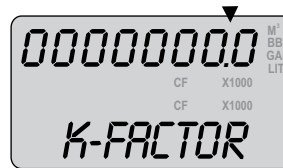

Enter the calculated divisor, starting with the last digit and entering digits right to left.

Press UP ARROW until the last digit of the calculated divisor is displayed.



Press LEFT ARROW to select the next digit to the left.



Repeat using UP and LEFT arrows to enter all remaining digits.

Press ENTER.

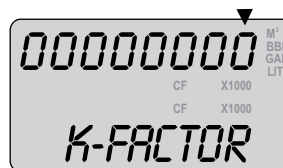

The Input Sensitivity menu prompt will appear immediately following the entry of the calibration factor. See [Setting Input Type and Sensitivity](#), page 30, for the input sensitivity configuration procedure.

## Setting Input Type and Sensitivity





The flowmeter signal can be obtained from a magnetic pickup or a pre-amplifier device.

The input sensitivity of the MC-III WP is measured in millivolts (mV) peak-to-peak. This is the threshold value at which the circuitry responds to a signal. If the input signal is less than this value, the MC-III WP will not count the electrical pulses as a valid turbine meter signal. If the input signal is equal to or greater than this value, the electrical pulses received at the input will be counted. Care must be taken to ensure that the input sensitivity is high enough to reject any electrical noise on the signal line, but not so high that flowmeter pulses are missed. The input sensitivity of the MC-III WP may be set to low, medium, or high when the input will be provided by a turbine flowmeter.

If the input will be provided in the form of a pulse from a pre-amplifier or other device (rather than directly from a turbine flowmeter), the “Pulse In” (pulse input) setting in the Input Sensitivity menu should be selected.

See [Section 2](#) for input wiring diagrams.

### To Set Input Type and Sensitivity:











Enter the K-Factor menu.	Press K-FACTOR MENU.	
Locate the input sensitivity setting.	Press ENTER, repeatedly if necessary, to bypass calibration factor. “INPUT SENSITIVITY” will scroll across the bottom display.	
<p>If the input is the turbine meter, select a sensitivity setting: low, medium, or high.</p> <p>If the input is provided by a different device, such as a pre-amplifier, select “Pulse in” (for pulse input).</p>	<p>Press UP ARROW to select a sensitivity setting.</p> <p>Press ENTER. “SAVING” will appear in the bottom display.</p>	  <div data-bbox="1047 1018 1429 1232" style="border: 1px solid gray; padding: 10px; display: inline-block;"> <p style="text-align: center;">Select low, medium, high, or Pulse In</p> <p style="font-size: 2em; text-align: center;">Lo</p> <p style="font-size: 1.5em; text-align: center;">INPUT SE</p> </div>

## Configuring the Total Display

The Total display can be configured for measuring volume in any of five preprogrammed units, any preprogrammed unit times 1,000, or a user-defined unit.

Users can specify a decimal point position, ranging from 0.1 to 0.0001 of a unit.

### To Configure the Total Display:

Enter the Display menu.	Press DISPLAY MENU.		
Select the unit of measure in which volume will be displayed.	Press UP ARROW until the correct unit is displayed. Note—If a calculated divisor was entered, select user-defined (no units visible).		
	To read the volume in terms of thousands of units (ex. 1.0 = 1,000 bbl), continue pressing UP ARROW until both the unit of choice and the X1000 option are displayed.		
Enter the decimal point position.	Press LEFT ARROW three times, or until the decimal point in the Total display begins blinking.		
	Press UP ARROW to change the position of the decimal point.		
	Press ENTER. "SAVING" will appear in the bottom display.		

**Important:** Before enabling or disabling the “× 1000” unit option for displaying flow totals, clear the total display to zero. If the total is not cleared, the accumulated total displayed will represent a combination of two different units and will not provide an accurate flow reading.











## Configuring the Rate Display

The Rate display comprises two parts: a volume unit and a time-base unit. The volume portion of the Rate display can be configured in one of five preprogrammed engineering units or in a user-defined unit (for use with a calculated divisor). To display the volume portion in multiples of 1,000 units, continue scrolling through the volume unit options until the ×1000 entry is displayed, along with the appropriate unit of measure.

The time-base portion of the Rate display can be configured in one of four preprogrammed engineering units: per day, per hour, per minute, or per second.

Users can specify a decimal point position, ranging from no decimal up to 0.001 of a unit.

### To Configure the Rate Display:

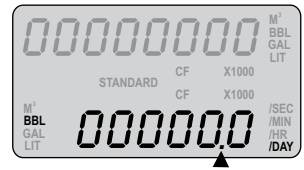
Enter the Display menu.	Press DISPLAY MENU.		
Enter the volume factor used to express flow rate (Ex.: bbl in bbl/day).	<p>Press LEFT ARROW. The volume unit of measure in the bottom portion of the LCD window should begin blinking.</p> <p>Press UP ARROW until the desired volume unit of measure is displayed. Note—If a calculated divisor was entered, select user-defined (no units visible).</p>	  	
Enter the time-base factor used to express flow rate (Ex. /day in bbl/day).	<p>Press LEFT ARROW. The time-base factor in the bottom portion of the LCD window should begin blinking.</p> <p>Press UP ARROW until the desired time-base factor is displayed.</p>	  	
Enter the decimal point position.	<p>Press LEFT ARROW twice, or until the decimal point in the Rate display begins blinking.</p> <p>Press UP ARROW to change the position of the decimal point.</p> <p>Press ENTER. "SAVING" will appear in the bottom display.</p>	    	

## Configuring the 4-20 mA Rate Output

**WARNING**

Do not make or break any connections on the 4-20 mA current loop unless the area is known to be non-hazardous.

**Caution:** Before performing any 4-20 mA configuration, ensure that all peripheral equipment connected to the 4-20 mA current loop is either disconnected or disabled. Configuring and testing the 4-20 mA output feature on the MC-III WP with the peripheral equipment in operation may cause false alarms or erroneous operation of the peripheral device or associated equipment.

The MC-III WP has a 4-20 mA output feature that represents flow rate. Zero and full-scale values can be configured to represent any flow rate range within the range of the flowmeter.

The low (or zero) setting is the flow rate value that will produce a 4-mA output. The high (or full-scale) setting is the flow rate value that will produce a 20-mA output. Typically, the high value is greater than the low value; this scenario is defined as “direct mode” in Figure 3.1.

Alternatively, users may configure the 4-mA and 20-mA outputs to have an inverse relationship, such that the high value is less than the low value. This scenario is defined as “indirect mode” in Figure 3.1.

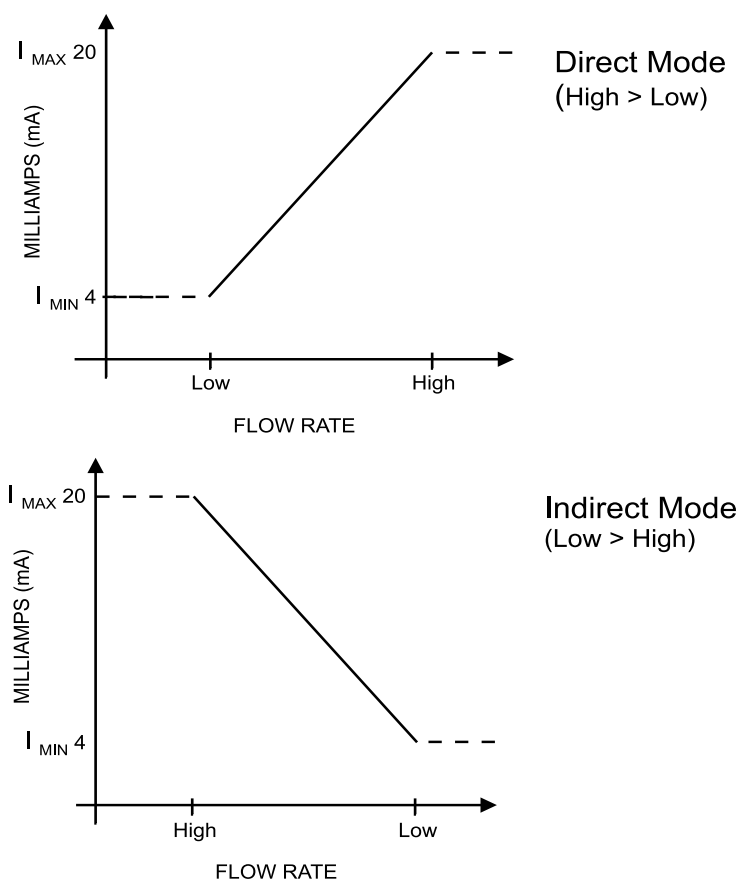

Figure 3.1—Two options for configuring a 4-20 mA output

See [Section 2](#) for instructions on installing and wiring the 4-20 mA rate output.

Flow rates in-between the minimum and maximum rate setpoints will result in an output of current between 4 mA and 20 mA according to the following calculation:

$$I_{OUT} = \frac{[I_{MAX} - I_{MIN}]}{High - Low} \times [RATE_{CURR} - Low] + I_{MIN}$$

Where:

$I_{OUT}$  = output current

$I_{MAX}$  = maximum current output (20 mA)

$I_{MIN}$  = minimum current output (4 mA)







High = programmed flow rate that produces a 20-mA output

Low = programmed flow rate that produces a 4-mA output

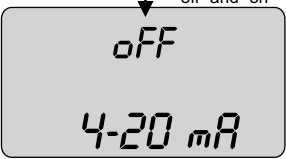
$RATE_{CURR}$  = flow rate



**To Configure the 4-20 mA Output:**

<p>Enter the Output menu.</p>	<p>Press OUTPUT MENU.</p>		
<p>Enable or disable the 4-20 mA output.</p>	<p>Press UP ARROW to toggle output to "on" or "off".</p> <p>Press ENTER. If the 4-20 mA output is enabled, the LCD will display the "Low" flow rate and the decimal point in the numeric display will begin blinking.</p>	 	<p>Toggles between "off" and "on"</p> 
<p>Enter the decimal point position for the "Low" flow rate. The words "4-20 mA LOW" should appear at the bottom of the LCD.</p>	<p>Press UP ARROW to change the position of the decimal point.</p>		
<p>Enter the "Low" (4-mA) flow rate. Digits are entered from right to left.</p>	<p>Press LEFT ARROW until the rightmost digit in the top display begins blinking.</p> <p>Press UP ARROW to change the digit.</p> <p>Press LEFT ARROW to select the next digit to the left. Continue pressing UP ARROW and LEFT ARROW alternately to enter all remaining digits.</p> <p>Press ENTER. The LCD will display the "High" flow rate and the decimal point in the numeric display will begin blinking.</p>	   	
<p>Enter the decimal point position for the "High" flow rate. The words "4-20 mA HIGH" should appear at the bottom of the LCD.</p>	<p>Press UP ARROW to change the position of the decimal point.</p>		
<p>Enter the "High" (20-mA) flow rate. Digits are entered from right to left.</p>	<p>Press LEFT ARROW until the rightmost digit in the top display begins blinking.</p> <p>Press UP ARROW to change the digit.</p> <p>Press LEFT ARROW to select the next digit to the left. Continue pressing UP ARROW and LEFT ARROW alternately to enter all remaining digits.</p> <p>Press ENTER.</p>	   	

The Pulse Output menu prompt will appear immediately following the entry of 4-20 mA parameters. See [Configuring the Pulse Output](#), page 36, for the pulse output configuration procedure.

## Configuring the Pulse Output











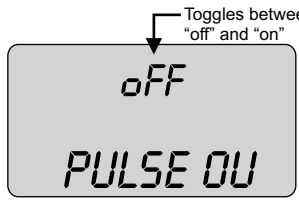

The pulse output feature of the MC-III WP is typically disabled to reduce current consumption. When the pulse output is not needed, Cameron recommends that this feature be disabled.

If the pulse output feature is required, the user will be prompted to enter a pulse output scale factor, which is the volume increment that will cause a pulse output to occur.

If the pulse output is configured via interface software instead of via the keypad Output menu, the user can also specify a pulse length (pulse width), which determines the length of each output pulse in milliseconds (ms). This parameter is configurable only with the interface software. See [Section 4](#) for more information.

See [Section 2](#) for instructions on installation and field wiring of the pulse output feature.

### To Configure the Pulse Output:







Enter the Output menu.	Press OUTPUT MENU.		
Locate the Pulse Output setting.	Press ENTER repeatedly until the words "Pulse Output" appear in the lower display.		
Enable or disable the pulse output.	<p>Press UP ARROW to toggle output to "on" or "off".</p> <p>Press ENTER. If the pulse output is enabled, the LCD will display "Pulse Output Scaler" and the decimal point in the numeric display will begin blinking.</p>	 	
Enter the decimal point position for the output scale factor.	Press UP ARROW to change the position of the decimal point.		
Enter the pulse output scale factor. Digits are entered from right to left.	<p>Press LEFT ARROW until the rightmost digit in the top display begins blinking.</p> <p>Press UP ARROW to change the digit.</p> <p>Press LEFT ARROW to select the next digit to the left.</p> <p>Repeat using UP and LEFT arrows to enter all remaining digits.</p> <p>Press ENTER.</p>	   	

The Slave Address menu prompt will appear immediately following the entry of pulse output parameters. See [Entering the Slave Address](#), page 37, for information on entering the slave address.

## Entering the Slave Address

The slave address is a setting used in Modbus® communications. It is a number that ranges from 1 to 65535, excluding 252 to 255 and 64764. If the Modbus® request message contains the matching address, the device will respond to the request. In network arrangements, the device must have a unique slave address. For more information about Modbus® communications, refer to the protocol manual section. If Modbus® communications are not used, leave the slave address at the factory setting (1).

### To Enter Slave Address:





Enter the Output menu.	Press OUTPUT MENU.	
Locate the Slave Address setting.	Press ENTER repeatedly until the words "Slave Address" appear in the lower display.  The rightmost digit in the top display will begin blinking.	 
Enter the Slave Address. (range: 1 to 65535, excluding 252 to 255 and 64764)	Press UP ARROW until the correct digit is displayed.  Then press LEFT ARROW to select the next digit to the left.  Repeat using UP and LEFT arrows to enter all remaining digits.  Press ENTER.	  

The Baud Rate menu prompt will appear immediately following the entry of the slave address. See *Entering the Baud Rate* below for the baud rate entry procedure.

## Entering the Baud Rate

The baud rate is the number of bits per second that are on the serial port. This setting must match the setting of the master device polling the MC-III WP or the serial port. This only applies to the Modbus® communications; if Modbus® communications are not used, leave the baud rate at the factory setting (9600).

### To Enter the Baud Rate:

Enter the Output menu.	Press OUTPUT MENU.	
Locate the Baud Rate setting.	Press ENTER repeatedly until the words "Baud Rate" appear in the lower display.	 
Enter the baud rate.	Press UP ARROW until the correct baud rate is displayed.  Press ENTER. "SAVING" will appear in the bottom display.	 



## Section 4—Configuration and Operation via Software

The MC-III™ interface software provides easy access to all configuration parameters and is the quickest way to configure the device. Instead of navigating keypad menus, users enter configuration parameters with their computer keyboard.

While basic parameters can be configured with the keypad (see [Section 3](#)), the interface software is the only means of accessing every configurable parameter. For example, multipoint calibration for liquid or gas measurement and gas volume correction parameters for measuring gas in standard cubic feet must be configured via the interface software.

[Table 4.1](#), page 49, provides a quick reference for determining whether a configurable parameter is accessible through both the keypad menu and the interface software, or only through the interface software.

### Installing the Software

The MC-III interface software is stored on a CD that is shipped with each instrument, and it installs directly onto a PC or laptop. To install the interface software on a computer, perform the following steps:

1. Place the MC-III CD in your CD-ROM drive.
2. The MC-III install screen will load automatically.
3. Click on “Next” to initiate the installation, and follow the instructions on the screen. An MC-III icon (Figure 4.1) will appear on the desktop of the user’s PC or laptop when installation is complete.

To access the interface software, click on the MC-III icon on your desktop or go the Start menu and select Programs>NuFlo>MC-III>MC-III.



Figure 4.1—MC-III desktop icon

### Accessing Help

The Help menu, accessible from the task bar at the top of the Welcome screen ([Figure 4.2](#), page 40), provides access to documentation designed to assist the user in installing, configuring, and operating the MC-III WP flow analyzer. This documentation includes:

- a “read me” file for general reference (includes contact information for technical assistance)
- an electronic copy of the user manual
- an electronic copy of the quick-start guide for installing and configuring the MC-III WP
- a COM troubleshooting guide for addressing communications errors (this guide will automatically display on screen when a communication error is detected)

The manuals can also be downloaded from Cameron’s Measurement Systems Division website, [www.c-a-m.com/flo](http://www.c-a-m.com/flo).

## Connecting to the Software

**Important:** Before attempting to load the interface software, verify that the MC-III WP is connected to a computer with an RS-485 to RS-232 converter (see [Optional Parts List](#), page 97). See [Section 2](#) for RS-485 output wiring diagrams ([Figures 2.16 through 2.18](#), pages 24 and 25).

Once the software is installed, the program will automatically launch with the click of the NuFlo MC-III icon on the desktop.

To connect to the MC-III software, perform the following steps:

1. Click on the NuFlo MC-III icon on the desktop, or select Start>Programs>NuFlo>MC-III>MC-III. The Welcome screen (Figure 4.2) will appear and a Select COM Port window will prompt the user to select a communications port be used for connecting with the MC-III WP (Figure 4.2).
2. Select a communications port from the dropdown list and click “OK.” The software will attempt to connect with the MC-III WP (via an RS-485 to RS-232 converter). This automatic launch feature is referred to as an “express connect.”
3. If the internal time and date programmed into the instrument differs from the time and date displayed on the computer by more than 60 seconds, the software will prompt the user to synchronize the instrument time/date to match the computer time/date ([Figure 4.3](#), page 41). This ensures that the instrument displays correct time, regardless of time zone differences.

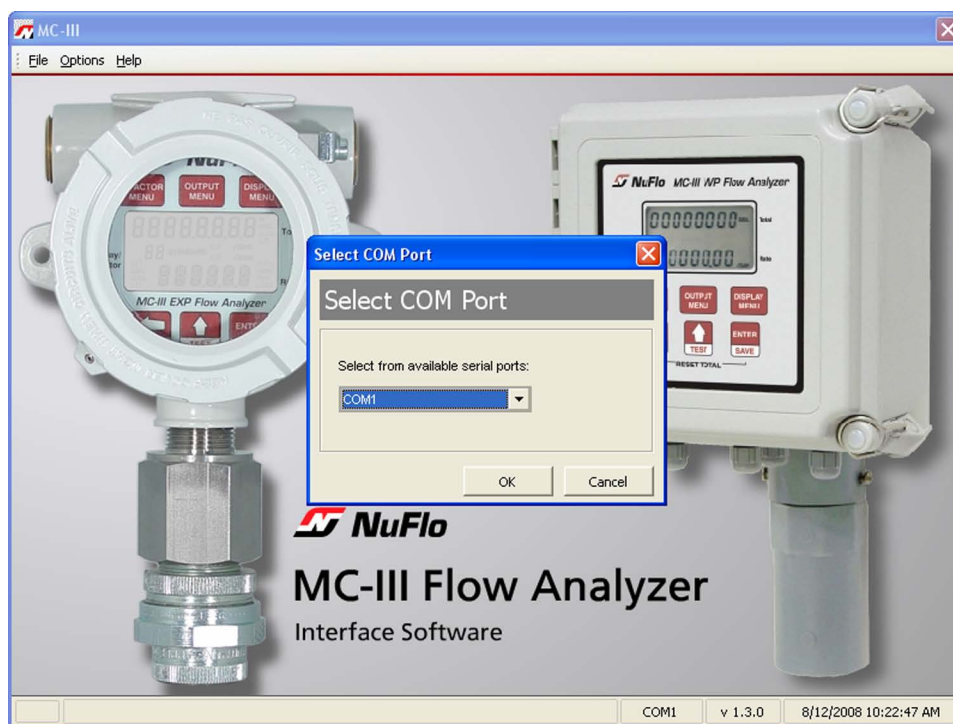

Figure 4.2—Select COM Port window

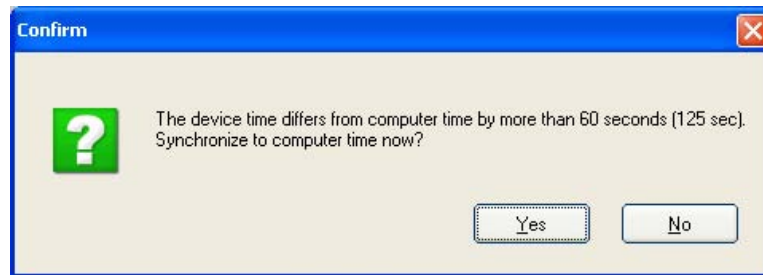

Figure 4.3—Prompt for authorizing time and date synchronization

The time difference setting used to generate a synchronize prompt is user-configurable. For more information, see [General Options](#), page A-1.

### Automating Functions on Software Startup

When the software connects with the instrument, the Device Autorun Options screen appears (Figure 4.4). From this screen, users can configure the instrument, download logs, or upload previously saved configuration settings.

A checkbox at the bottom of the Device Autorun Options screen allows the user to bypass the Device Autorun Options screen and perform a selected function each time the software connects to the instrument.

Example: To download all logs on connection, select Download all logs from the Device Autorun Options screen and check the “Always do...” checkbox. Each time the software computer connects to the instrument, the software will bypass the Device Autorun Options screen, open the Flow Archive screen, and download all logs. See [Section 5](#) for more information on flow logs.

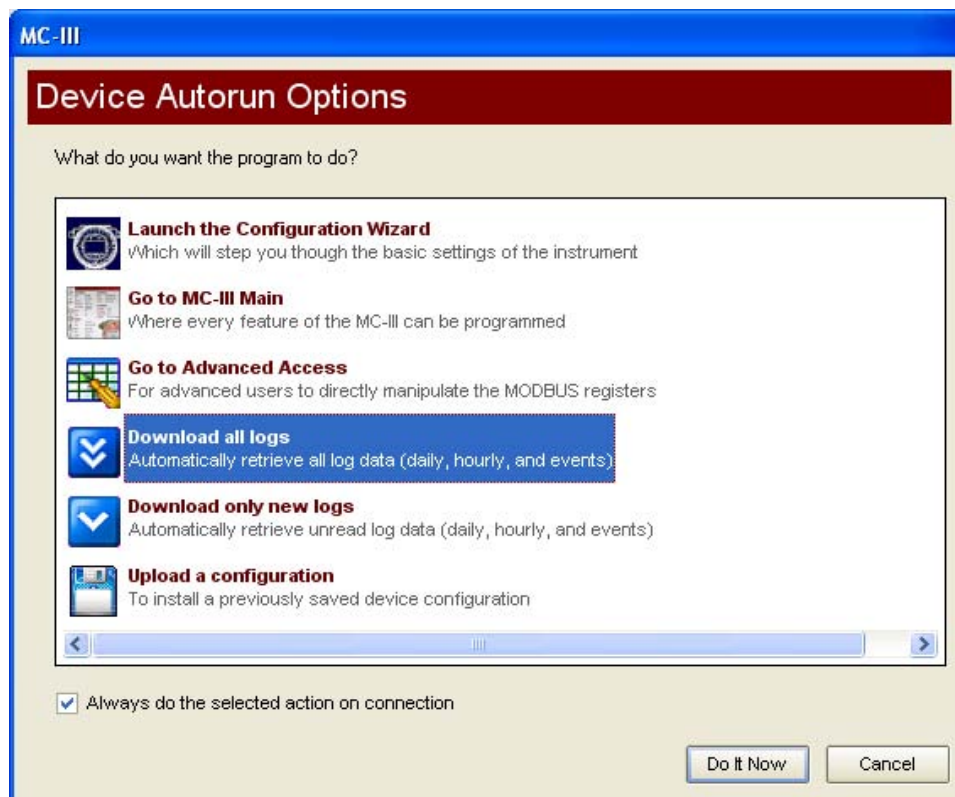

Figure 4.4—Device Autorun Options screen

## Changing Autorun Settings

To change an autorun setting—that is, to initiate an autorun action, to terminate an autorun action, or to change to a different autorun action—without exiting to the Welcome screen, choose Options/Program Options from the menu bar and select Autorun from the dropdown list (Figure 4.5).

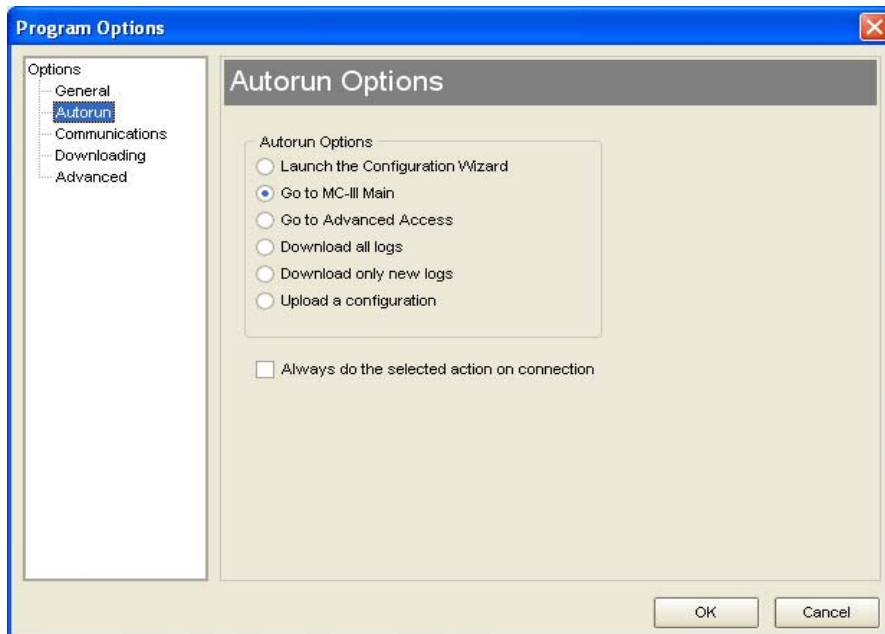

Figure 4.5—Options/Program Options screen for changing autorun settings

## Express Connect Option

By default, the MC-III interface software automatically attempts to connect to the instrument when a user clicks on the desktop application icon. For more information on disabling the “express connect” feature and changing communications options, see [Appendix A](#).

### Canceling Express Connect

To temporarily cancel the “express connect” function without exiting the software program, click in the LCD area of the device on the Welcome screen or choose File>Cancel Express Connect from the menu bar ([Figure 4.6](#), page 43). The software will stop all attempts to connect to the device. The “express connect” function will be restored when the user exits the program and attempts to re-open the software.



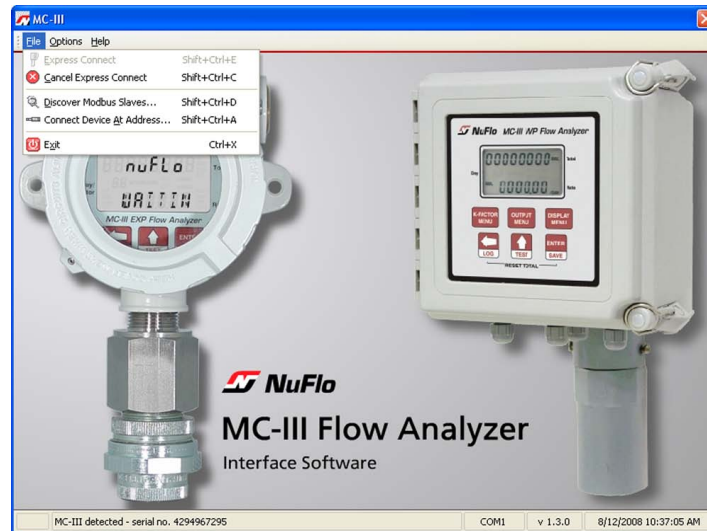

Figure 4.6—Cancel Express Connect option

To reattempt a connection to the device after canceling the “express connect” function, click the LCD on the Welcome screen again, or choose File>Express Connect from the menu bar.

### Changing the Communications Port

The computer will attempt to connect to the MC-III WP via the port that the user selects the first time he connects to the instrument. However, if a network dictates that the computer connect through another communications port (actual or virtual), the user must specify the appropriate COM port. To change the COM port setting, click on Options>Select COM Port (Figure 4.7), and select the appropriate COM port from the list of ports detected.



Figure 4.7—COM port selection menu

### Software Connection in Multi-Device Network

In most cases, the automatic launch (or “express connect”) feature is a convenient time-saver. However, if multiple devices are daisy-chained together in a network, this feature can interfere with the user’s ability to connect to a specific device. The software allows the user to temporarily disable the “express connect” feature and query the system for all connected devices. From the resulting list of devices, the user can then connect to the appropriate slave address.

To select a device from a network of instruments, perform the following:

1. From the Welcome screen, choose File>Cancel Express Connect (Figure 4.6).

2. Click File>Discover Modbus® Slaves.
3. Enter a range of addresses you want to search (Figure 4.8).
4. Enter the baud rate established for network communications.
5. Adjust the time-out setting, if necessary.
6. Click “Search.” The software will scan all addresses specified and display all instruments connected.
7. Click on the appropriate address to connect to a device.

---

**Important:** In daisy-chain configurations, verify that each device has a unique slave address.

---

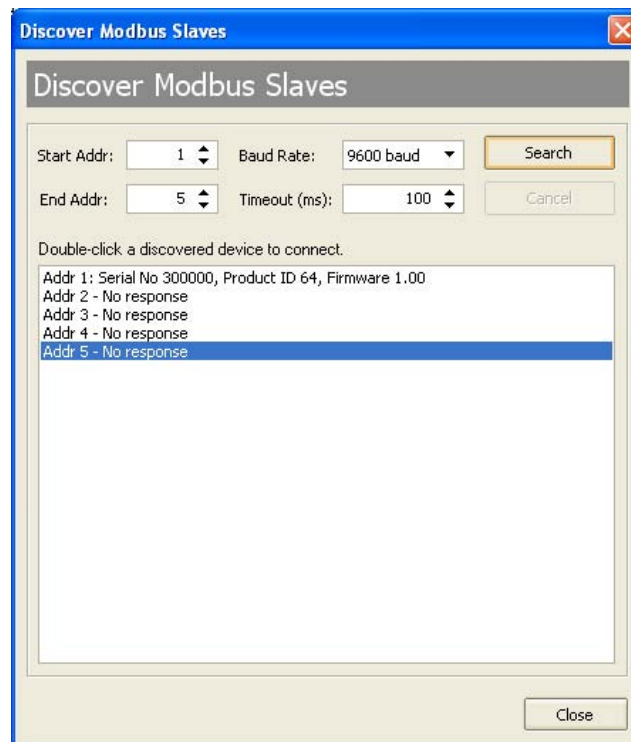

Figure 4.8—Automatic detection of all connected devices

A user who knows the address of a specific device may also connect to it by clicking File>Connect Device at Address (Figure 4.9).



Figure 4.9—Slave address selection screen

## Setting Log Download Preferences

The MC-III WP automatically saves daily flow logs on the contract hour, and hourly flow logs around the clock. The instrument also automatically creates an event record each time a user change is made. After downloading these logs from the instrument, the instrument saves the data in a file. By default, the logs are saved as .csv files.

The file format of the auto-save flow log and event log files is user-configurable. Users can configure the software to download the auto-save flow and event logs as Excel (.xls) files by selecting Options>Program Options>Downloading from the menu bar (Figure 4.10).

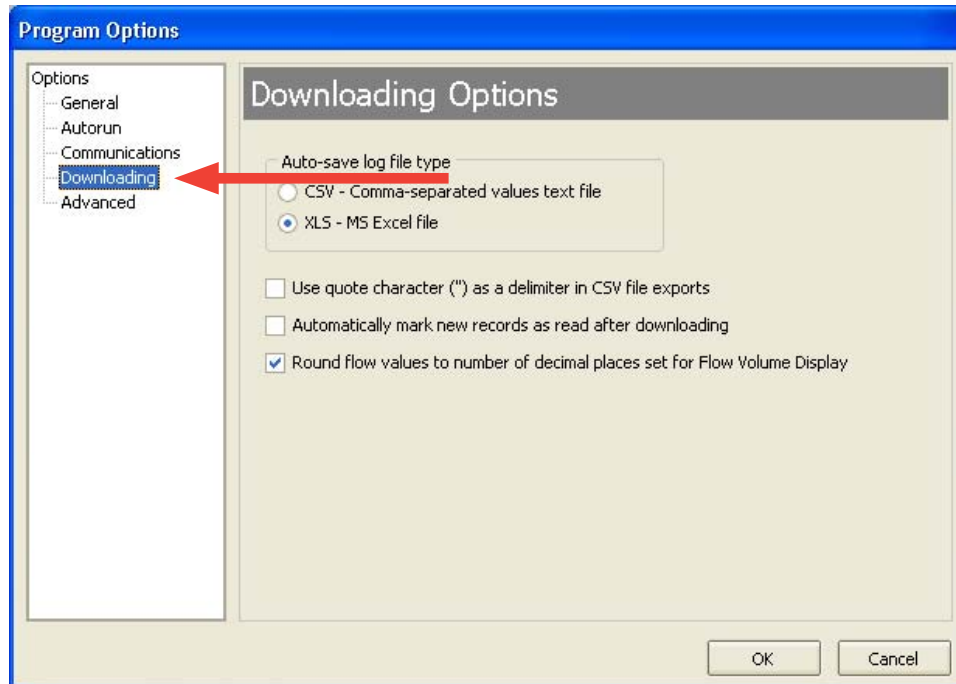

Figure 4.10—Log file type selection

## Configuring the MC-III WP

The MC-III WP offers three methods for configuring parameters:

- The “Configuration Wizard” (Figure 4.11) condenses the configuration process into nine easy-to-follow steps (compensated gas measurement and multipoint linearization are not supported in the wizard).
- The MC-III Main screen (Figure 4.12, page 47) gives users complete access to all configuration parameters.
- The Advanced screen (Figure 4.13, page 47) provides access to Modbus® registers that can be modified to change configuration parameters (recommended only for system configurators and host programmers).

If the desired configuration settings have been saved previously, the configuration file can also be uploaded, eliminating the need to re-input configuration data. See *Saving and Uploading Configuration Files*, page 71, for details.

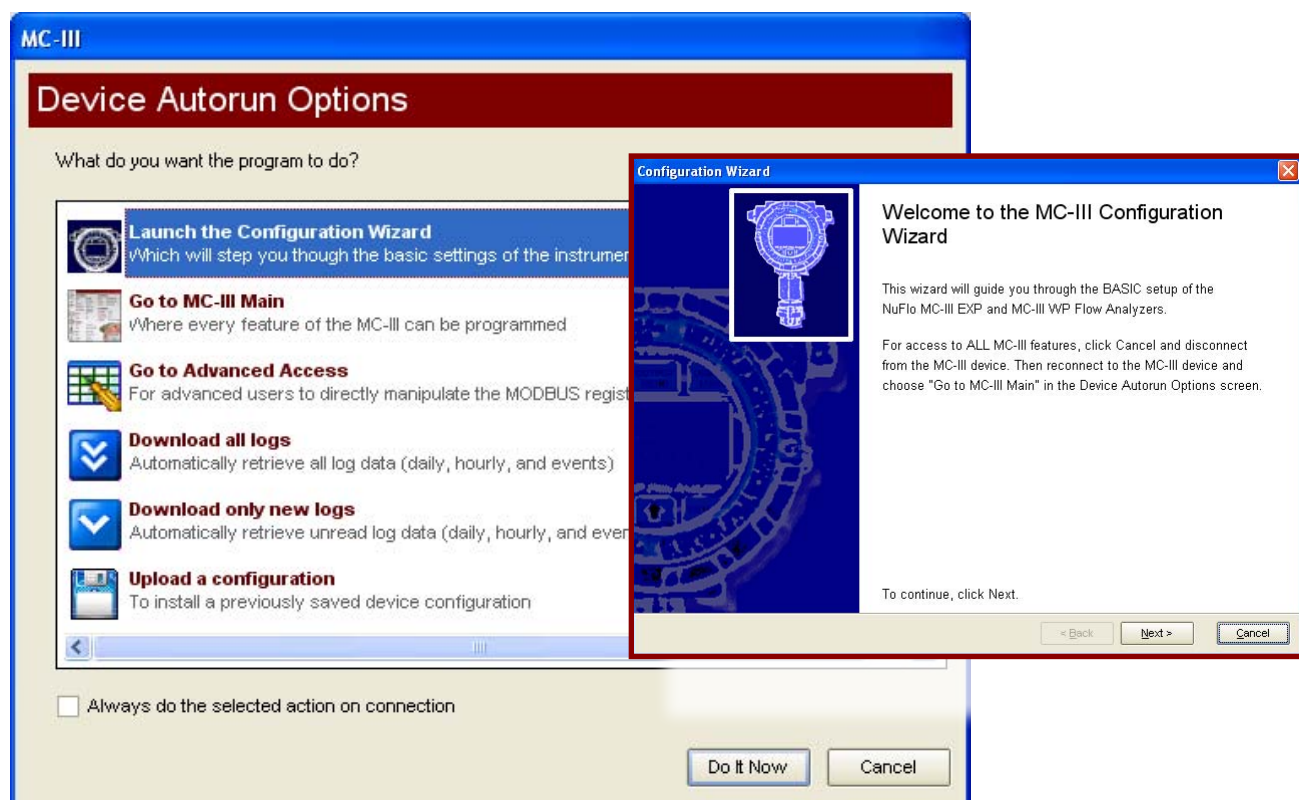

Figure 4.11—Configuration Wizard (for novice users)

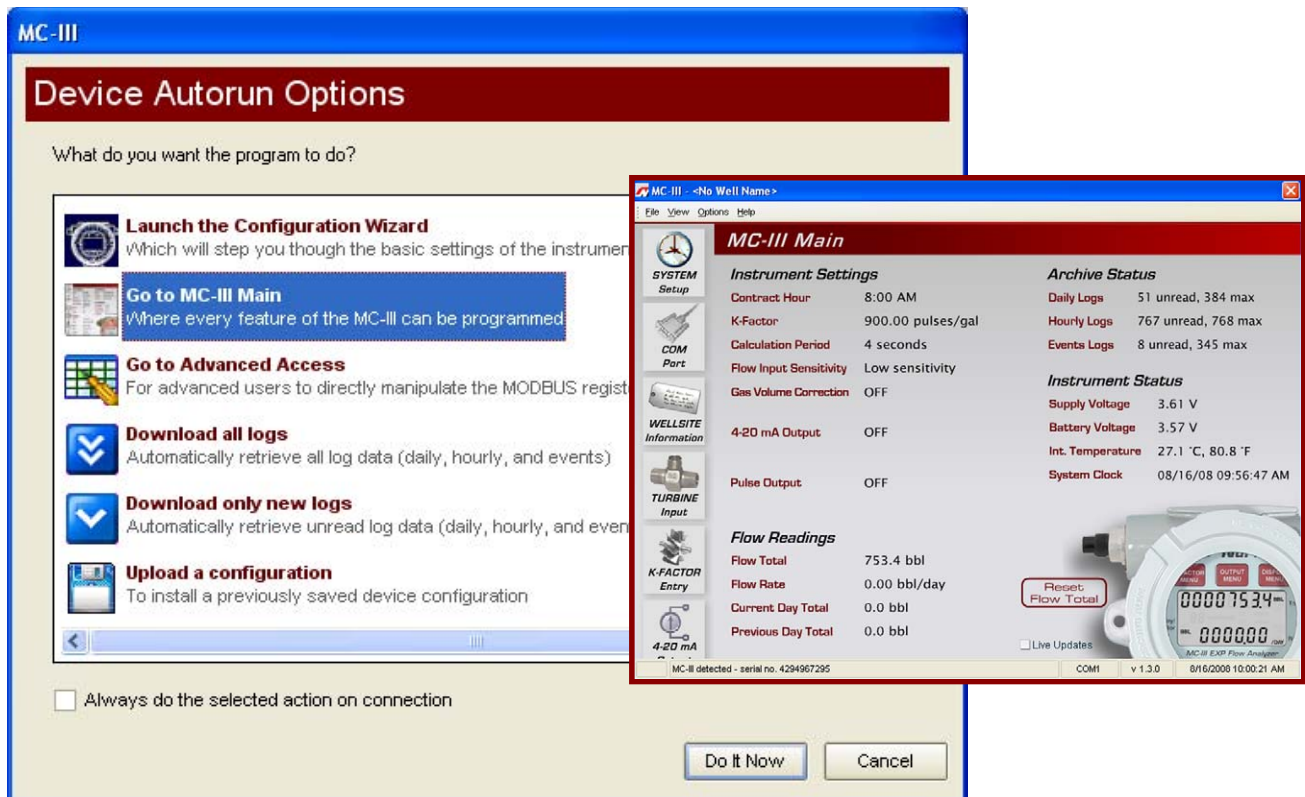

Figure 4.12—MC-III Main configuration option for complete access to configurable parameters

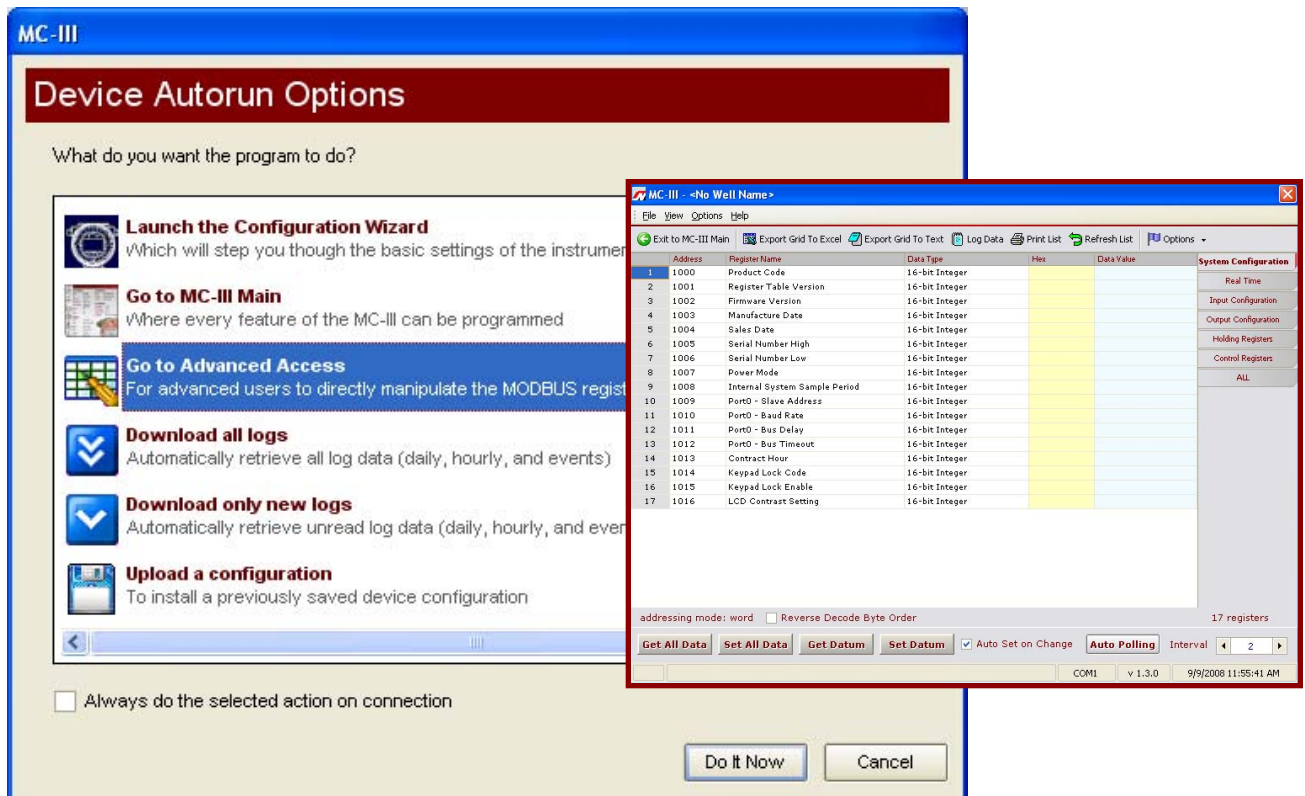

Figure 4.13—Advanced Access configuration option for system configurators and host programmers

## Configuration Wizard

The Configuration Wizard is ideal for first-time users who want to perform a basic calibration for liquid or gas measurement. By following the instructions on nine screens, even a first-time user can successfully configure the MC-III WP.

See [Table 4.1](#), page 49, for a list of settings that are configurable with the keypad, the software Configuration Wizard, and the software MC-III Main Screen.

---

**Important:** The Configuration Wizard does not allow multipoint calibration or gas volume correction. To select these parameters, the user must access the MC-III Main screen.

---

**Caution:** Do not use the Configuration Wizard to change individual settings. When the Configuration Wizard is used, system default settings are restored before the new settings entered in the Calibration Wizard are written to the program. Previous configuration settings are saved automatically in C:\NuFlo log data\MC-III\Config Backup Files.

---

### Using the Pencil Tool

The data entry fields in the Configuration Wizard are highly intuitive, and most can be completed by clicking in the field and entering new data or selecting a checkbox. For data fields that require the user to enter a value, such as a K-factor, and designate a decimal position, a pencil icon provides a link to a data-entry window.

To enter a new value, click on the pencil icon (Figure 4.14). A new window will appear, allowing the user to enter a new value, and designate the appropriate decimal position using a slide bar. This method ensures that the decimal point setting and data-entry resolution displayed in the software and on the instrument LCD correlate.

This tool is used to enter the calibration factor, flow rates for 4-20 mA output, and the scale factor for pulse output.

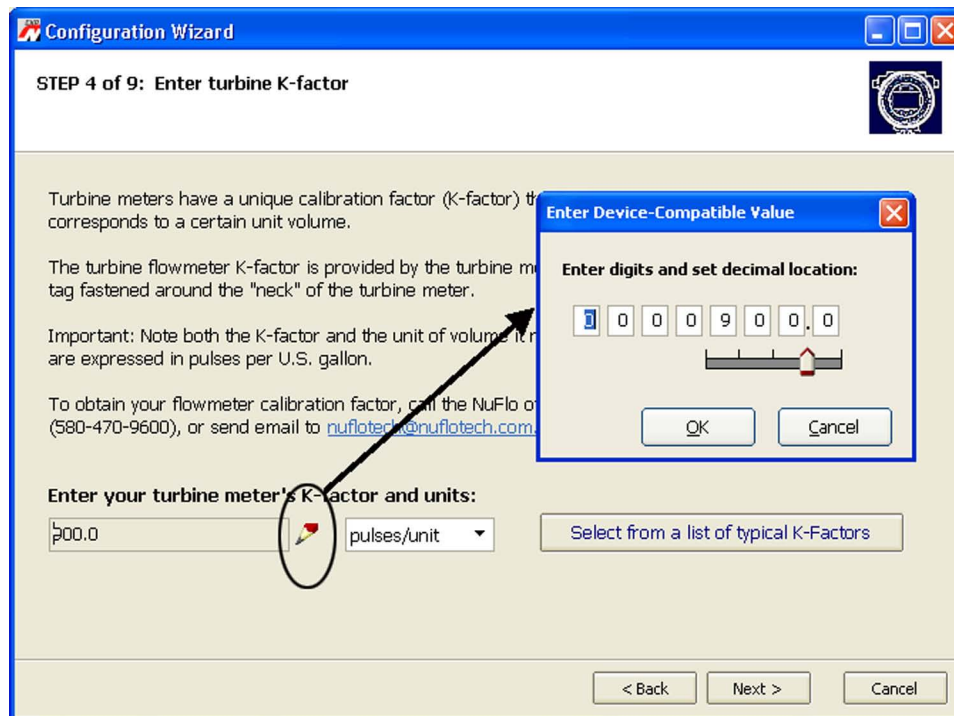

Figure 4.14—Pencil tool icon and data-entry window

**Table 4.1—Menus for Configuring Parameters**

<b>Configurable Parameter</b>	<b>Instrument Keypad</b>	<b>Configuration Wizard</b>	<b>Menu Screen (accessed from MC-III Main)</b>	<b>For information, see page ...</b>
Well Name	—	Step 1	Wellsite Information	58
LCD Contrast	—	—	System Setup	54
Security Setup	—	—	System Setup	55
Contract Hour	—	Step 2	System Setup	54
Volume Display (units, decimal location)	Yes	Step 5	Turbine Input	59
Rate Display (units, decimal location)	Yes	Step 5	Turbine Input	59
Input Type	Yes	Step 3	Turbine Input	60
Input Sensitivity	Yes	—	Turbine Input	60
Input Cut-off Thresholds	—	—	Turbine Input	60
Calculation Period (seconds)	—	—	Turbine Input	60
K-Factor	Yes	Step 4	K-Factor Entry	61
Multipoint K-Factor	—	—	K-Factor Entry	62
Gas Volume Correction	—	—	K-Factor Entry	63
4-20 mA Output	Yes	Step 6	4-20 mA Output	65
Pulse Output	Yes	Step 7	Pulse Output	69
Slave Address	Yes	Step 8	COM Port	56
Baud Rate	Yes	Step 8	COM Port	56
Bus Delay	—	—	COM Port	57
Bus Timeout	—	—	COM Port	57

## MC-III Main Screen

The MC-III Main menu screen (Figure 4.15) is the configuration hub of the MC-III WP. From the Main screen, users can

- review all current instrument settings and flow readings
- check the log archive and instrument status
- access all submenus for changing configurable parameters
- reset the total to zero

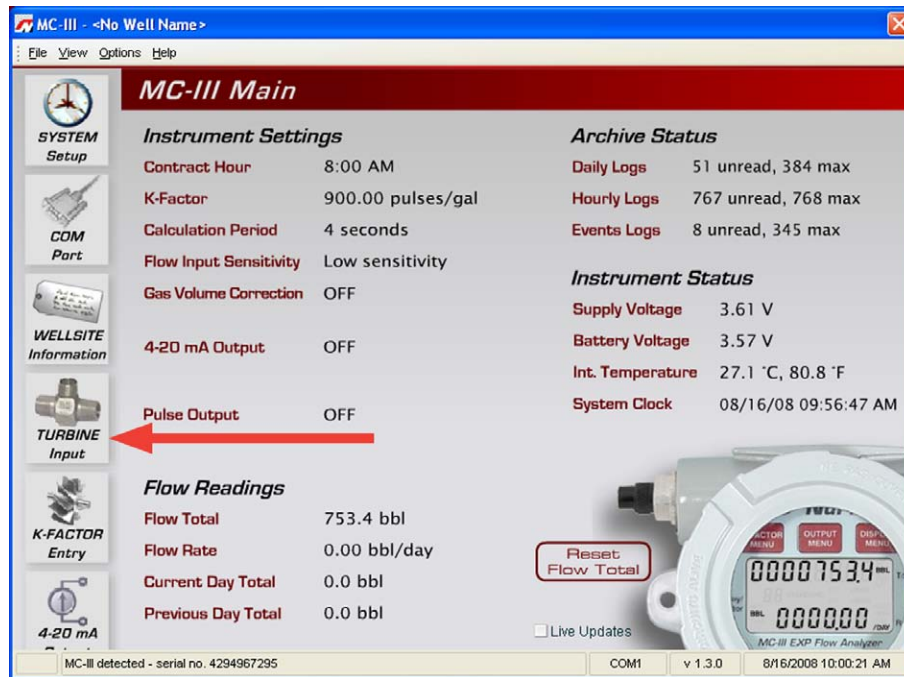

Figure 4.15—MC-III Main screen provides direct access to all menu functions using the scrolling menu bar at the left side of the screen.

### Data Display and Updates

Each time the software polls the instrument, a small icon appears briefly in the lower left corner of the screen. If the “Live Updates” checkbox in the lower right corner of the screen is checked, the instrument settings and the LCD displays will automatically update with each poll.

### “Live Updates” Checkbox

The “Live Updates” option is enabled by default. However, in the event that slow communication speeds are used or the system times out frequently, the user can uncheck the “Live Updates” checkbox and periodically query the system by clicking on the LCD graphic on the Main screen.

### Reset Flow Total Button

The flow total can be reset to zero at any time by clicking on the “Reset Flow Total” button.

### Scroll Bar

A scroll bar at the left side of the screen (Figure 4.15) gives the user easy access to any of seven configuration menus and two log archive screens (see [pages 52](#) and [53](#)). Using these menus, the user can change all configurable parameters of the instrument. Once the instrument has been configured, the Main screen access should always be used for changing individual parameters while retaining all other configuration settings.



## Buttons and Tools

### Apply and OK Buttons

Changing parameters on a submenu screen involves selecting the proper screen from the scroll bar, selecting information from dropdown menus or entering data in data fields, and saving the data using the “Apply” or “OK” button. “Apply” allows the user to apply the changes without leaving the submenu screen. “OK” allows the user to apply the changes and returns the user to the Main screen.

### Refresh and Cancel Buttons

To update the display of settings on any submenu screen by forcing a reread of configured parameters, press the “Refresh” button. The “Refresh” button clears any entry that has not been applied, therefore, pressing “Refresh” is also a convenient way to erase an incorrect entry. A “Cancel” button allows the user to close out of a submenu screen without saving new settings and returns the user to the Main screen.

### Pencil Tool for Data Entry

The data-entry fields in the MC-III Main sub-menu screens are highly intuitive, and most can be completed by clicking in the field and entering new data, or selecting a checkbox. For data fields that require the user to enter a value, such as a K-factor, and designate a decimal position, a pencil icon provides a link to a data-entry window.

To enter a new value, click on the pencil icon (Figure 4.16). A new window will appear, allowing you to enter a new value, and designate the appropriate decimal position using a slide bar. This method ensures that the decimal point setting and data-entry resolution displayed in the software and on the instrument LCD correlate.

This tool is used to enter the calibration factor, flow rates for 4-20 mA output, and the scale factor for pulse output.

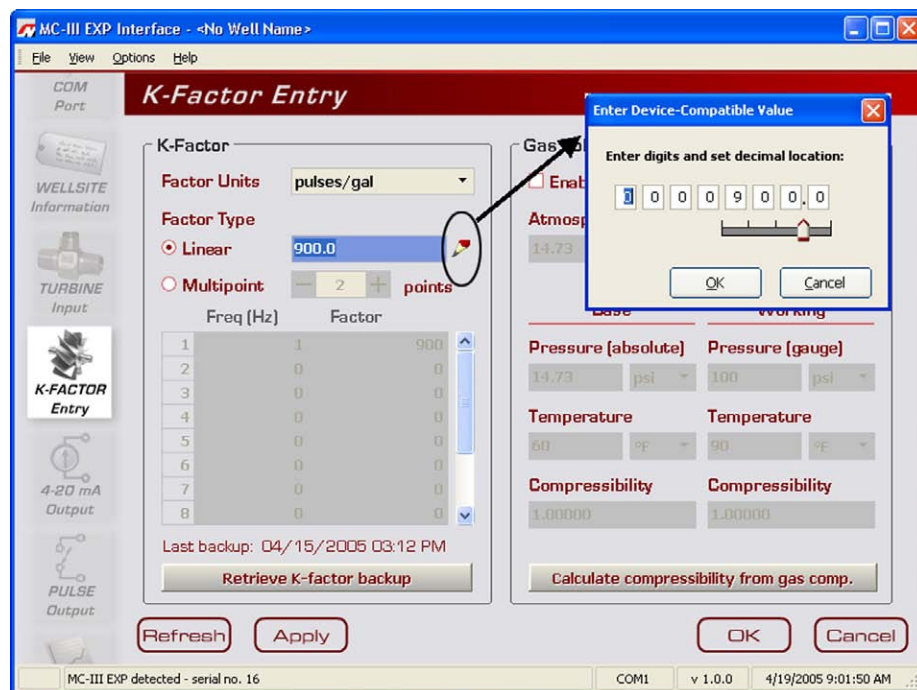
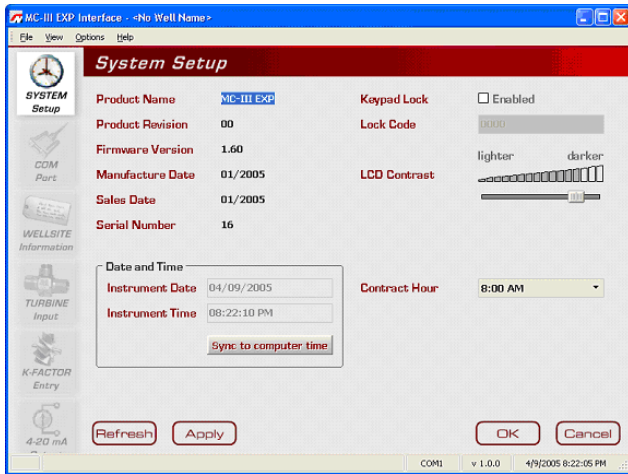
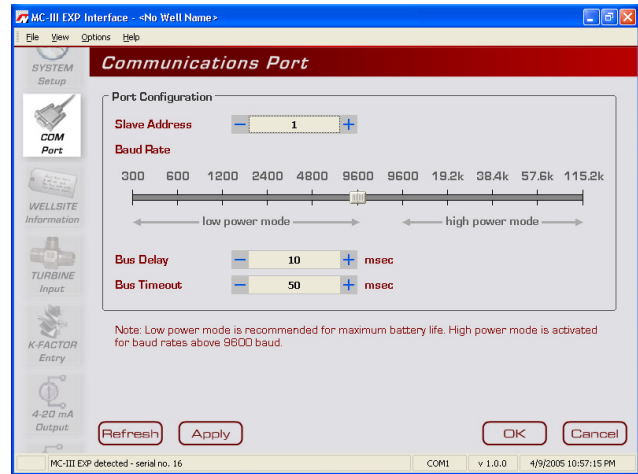

Figure 4.16—Pencil tool icon and data-entry window

### Configuration Submenus (MC-III Main)



System Setup



Communications Port



Wellsite Information

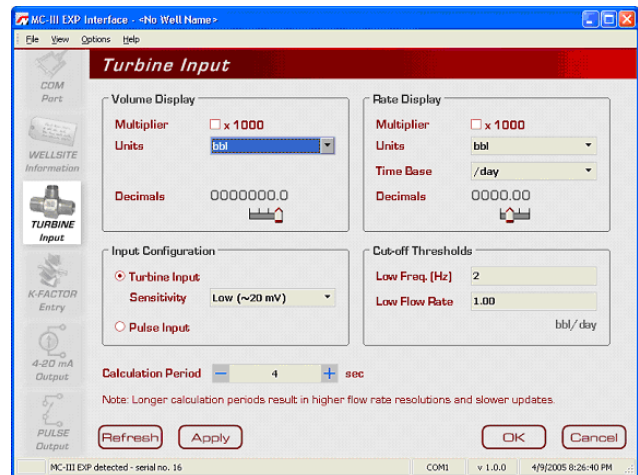

Turbine Input

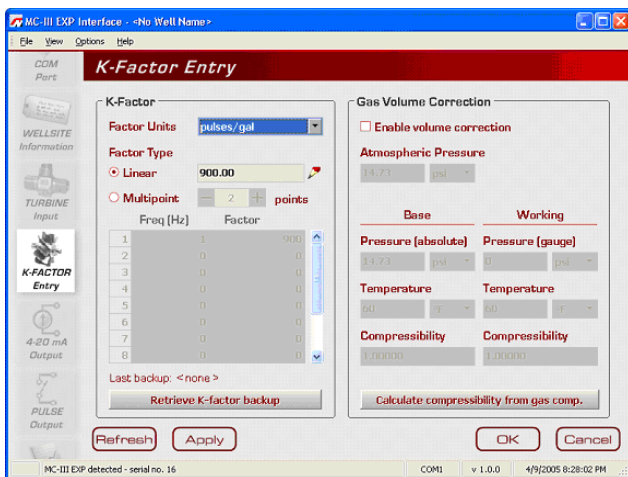

K-Factor Entry

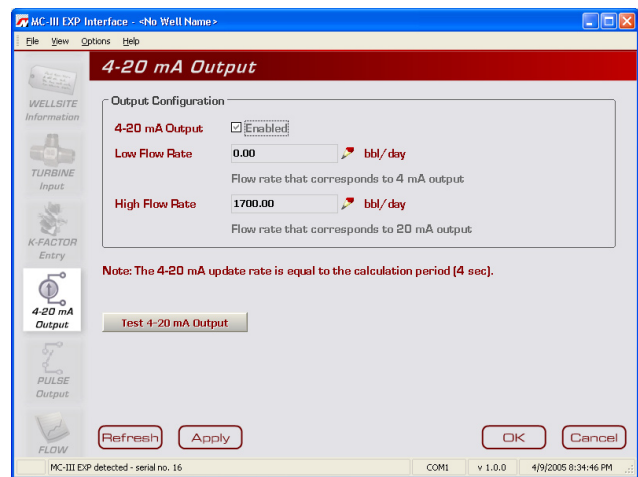

4-20 mA Output

### Configuration Submenus (cont'd)



Pulse Output

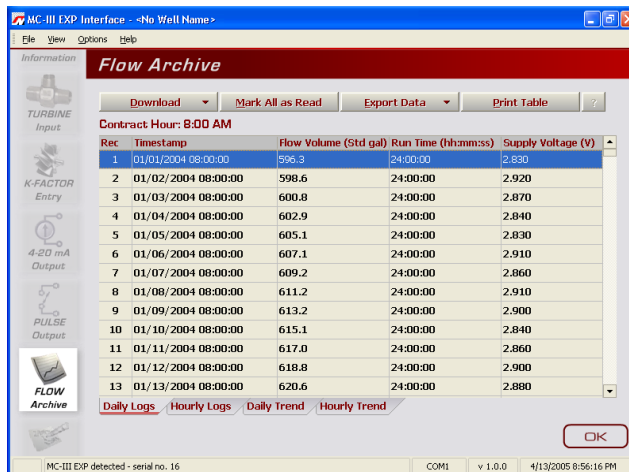

Flow Archive

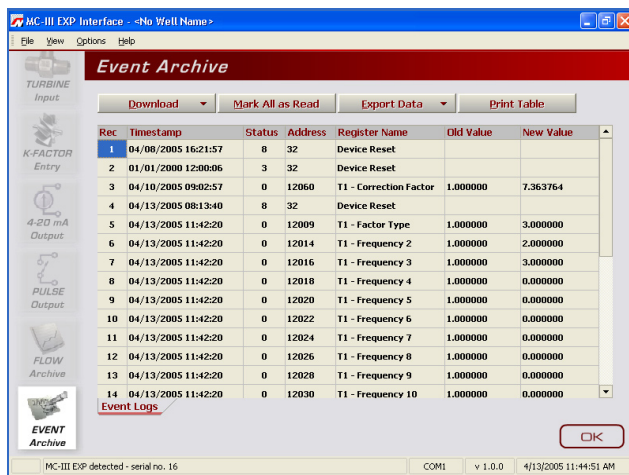

Event Archive

## System Setup

The first of the submenus on the Main screen scroll bar—System Setup—allows users to adjust time/date, set the desired contract hour, enable or disable the password-protected security option, and adjust the LCD contrast.



Figure 4.17—System Setup screen

### Time/Date Synchronization

The MC-III WP includes a real-time clock for timekeeping and log time stamps. Upon connecting with the instrument, the interface software prompts the user to synchronize the instrument time and date with the time and date displayed on the computer if the time difference exceeds 60 seconds. To change the clock synchronization threshold to a value other than 60 seconds, see [General Options](#), page A-1.

A user can synchronize the instrument and computer clocks at any time by clicking the “Sync to Computer Time” button on the System Setup screen.

### Contract Hour

Hourly flow totals are logged in the archive on the hour. The contract hour determines the exact time when the daily flow total is logged. The contract hour is easily adjusted by selecting the appropriate hour from the dropdown list on the System Setup screen.

### LCD Contrast Adjustment

LCD contrast is temperature-dependent and may require adjustment for optimum readout visibility. A slide bar allows users to quickly adjust the contrast of the LCD.

**Security Setup**

Setting a keypad security code will prevent unauthorized personnel from altering calibration data or resetting totals, and the security function is recommended to preserve data integrity of the system. The MC-III WP's keypad security feature is disabled at the factory.

To enable the security protection, check the “Keypad Lock” checkbox on the System Setup screen, and enter a four-digit lock code in the field below the checkbox. (Do not use “0000.”) The security feature will be activated the next time a user attempts to access the keypad.

**Firmware Version Number**

As firmware is upgraded, firmware version numbers change. The firmware version number shown may assist technical support personnel in troubleshooting an operational issue.

**Serial Number**

The serial number of your MC-III WP can be used to track the history of your unit to include warranty status.

## Communications Port

The Communications Port screen (Figure 4.18) allows users to change the settings that are required for Modbus® communication.

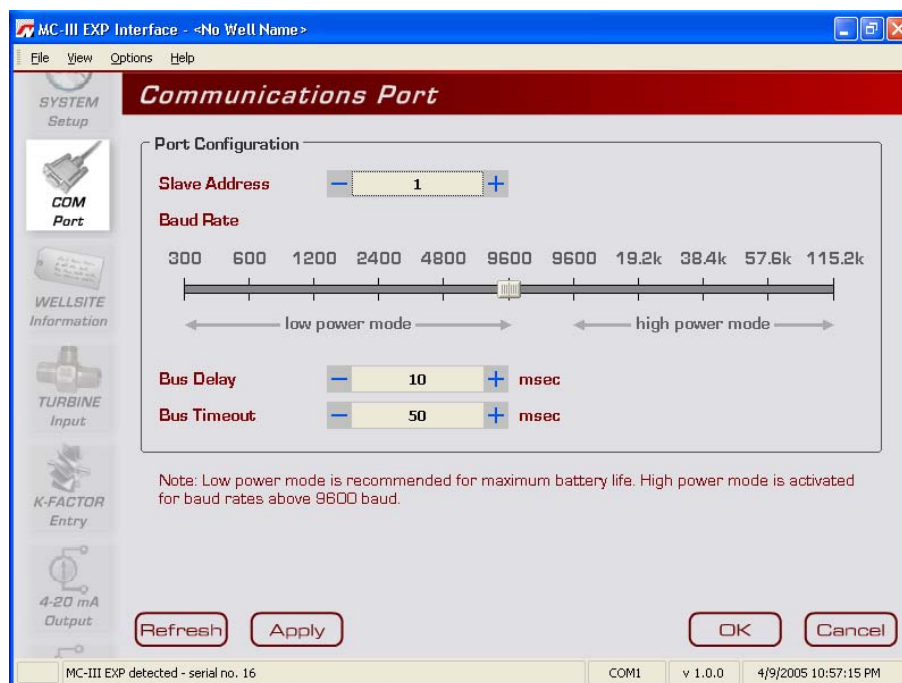

Figure 4.18—Communications Port screen

### Slave Address

The slave address allows the MC-III WP to communicate with other devices via Modbus®. It is a number that ranges from 1 to 65535, excluding 252 to 255 and 64764. If a Modbus® request message contains the matching slave address, the device will respond to the request. In network arrangements, the slave device must have a unique address. For more information about Modbus® communications, refer to the protocol manual section.

To change the slave address, select a number using the “plus” and “minus” buttons on the screen, or using the page-up and page-down keys on your computer keyboard. If Modbus® communication is not used, leave the slave address at the factory setting (1).

### Baud Rate

The baud rate is the number of bits per second that are on the serial port. Baud rates supported by the MC-III WP range from 300 to 115.2K. This setting must match the setting of the master device polling the MC-III WP or the serial port. This only applies to the Modbus® communications; if Modbus® is not used, set the baud rate to 9600.

To change the baud rate, slide the selector bar to the appropriate setting. The default setting is 9600 baud. Note that the 9600 baud rate is available in both the low-power and high-power modes. When the instrument is powered by batteries alone, the low-power mode is recommended.

### Auto-Negotiate Option

When connected devices are capable of switching baud rates automatically or when devices are directly connected to an MC-III WP, a user may configure the MC-III interface to automatically negotiate the fastest

baud rate during device connection. This “negotiated” baud rate does not replace the configured baud rate, but rather provides a temporary boost of baud rate while the computer is connected to the device for faster downloads. After the software disconnects, the device reverts to the configured baud rate.

By default, this function is disabled. To enable automatic baud rate negotiation on device connect, choose Options/Program Options from the menu bar, select Communications from the dropdown options list, check the “Attempt auto-negotiation...” checkbox, and click “OK” (Figure 4.19). To initiate an immediate search for the fastest baud rate without exiting to the Welcome screen, check the “Enable auto-negotiated baud rate” checkbox, click the “Test Now” button to the right of the checkbox, and click “Yes” at the prompt in the Confirm dialog box. See also *Auto-Negotiate Option*, page A-4.

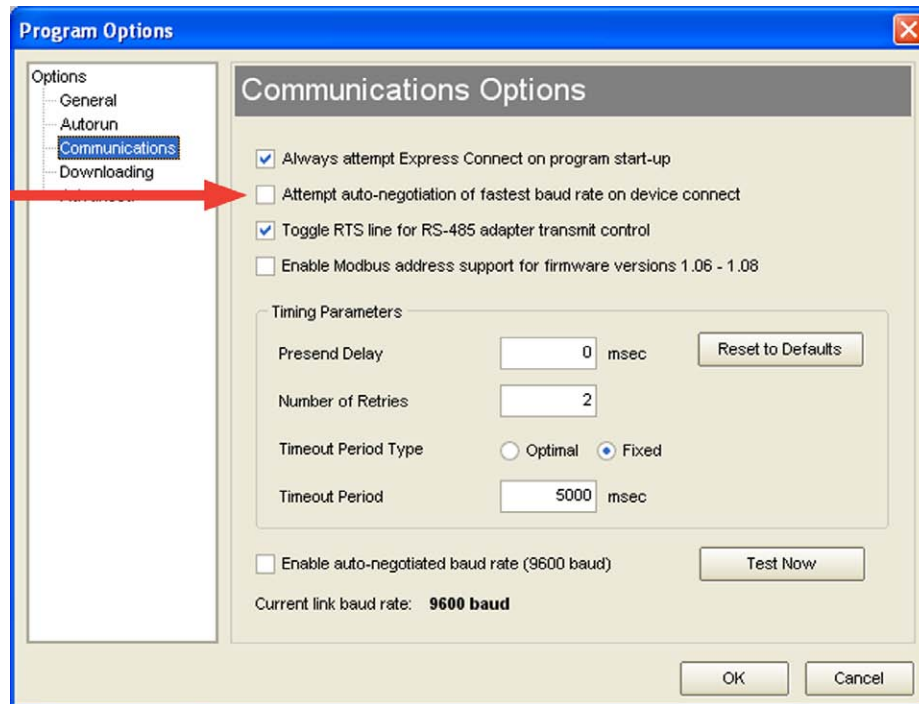

Figure 4.19—Communications Options screen

### Bus Delay

Bus delay is the amount of time (in milliseconds) that passes before the MC-III WP attempts to take control of the RS-485 bus and transmit a message back to the requesting device. The MC-III WP responds very quickly to incoming Modbus® requests—in some cases, too quickly. A configurable delay allows the user to control this response time. A setting of 10 ms is normally sufficient, but may require adjustment when the MC-III WP is communicating with a radio or other end device that responds more slowly.

### Bus Timeout

Bus timeout is the amount of time (in milliseconds) that must pass to cause the MC-III WP to reset its internal Modbus® message handler. The default value of 50 ms is normally sufficient.

### Software Communication Options

The default timing parameters in the MC-III WP support communication with most radios and Modbus® devices. However, if the MC-III WP is used with a device that has a very slow response time, it may be necessary to adjust the timing parameters to enhance performance. For information about these parameters, see *Appendix A*, Software Program Options.

## Wellsite Information

The Wellsite Information screen (Figure 4.20) allows users to enter information that distinguishes the wellsite, such as company name, well name, and site location. While most of the fields on this screen are optional, a well name should be assigned.

The well name (limited to 20 characters in length) will also serve as the name of the folder where flow logs generated by the MC-III WP software will be archived. If a well name is not entered on this screen, logs will be saved in a folder titled “NO\_WELLNAME.”

The screenshot shows the 'Wellsite Information' screen in the MC-III EXP software. The window title is 'MC-III EXP Interface - <No Well Name>'. The menu bar includes 'File', 'View', 'Options', and 'Help'. The left sidebar has icons for 'Setup', 'COM Port', 'WELLSITE Information' (which is highlighted), 'TURBINE Input', 'K-FACTOR Entry', and '4-20 mA Output'. The main area is titled 'Wellsite Information' and contains the following fields: 'Company Name', 'Well Name', 'Site ID', 'Site Location', 'Tag Name', 'Legal Description', 'Sensor Model No.', 'Sensor Serial No.', 'Measurement Type', and 'User Note'. At the bottom, there are buttons for 'Refresh', 'Apply', 'OK', and 'Cancel'. The status bar at the bottom displays 'MC-III EXP detected - serial no. 1007', 'COM1', 'v 1.0.0', and '6/17/2005 10:37:40 AM'.

Figure 4.20—Wellsite Information screen



## Turbine Input

The Turbine Input screen (Figure 4.21) allows users to configure the displays for volume and rate, select the type of input to be used (turbine input or pulse input), determine cut-off thresholds for measuring flow, and determine the display update frequency.

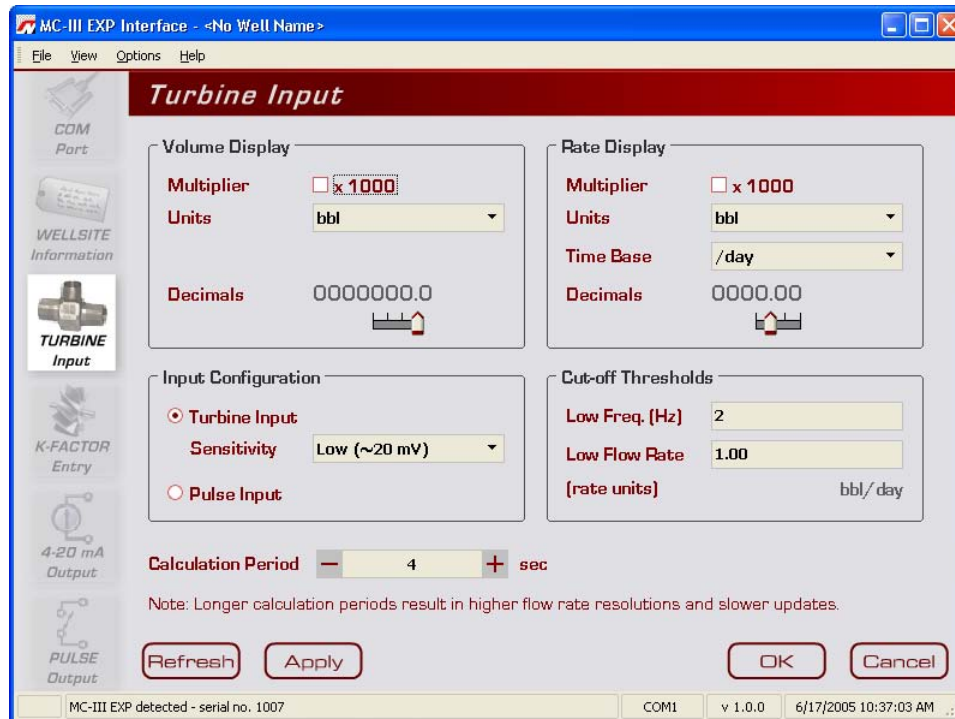

Figure 4.21—Turbine Input screen

### Volume Display

The Volume display can be configured to display totals in one of five preprogrammed engineering units or in a user-defined unit (for use with a calculated divisor).

---

**Important:** If volume is to be measured in user-defined units, the K-Factor unit must also be entered as “pulses per unit.” For more information, see [Entering a Calculated Divisor](#), page 29.

---

To display the volume in multiples of 1,000 units, check the “Multiplier” checkbox. Users can specify decimal point position, from 0.1 to 0.0001 of a unit, using the slide bar on the Turbine Input screen.

---

**Important:** Before enabling or disabling the “× 1000” unit option for displaying flow totals, clear the total display to zero. If the total is not cleared, the accumulated total displayed will represent a combination of two different units and will not provide an accurate flow reading.

---

### Rate Display

The Rate display comprises two parts: a volume unit and a time-base unit. The volume portion of the Rate display can be configured in one of five preprogrammed engineering units or in a user-defined unit (for use with a calculated divisor).

To display the volume portion in multiples of 1,000 units, check the “Multiplier” checkbox.

The time-base portion of the Rate display can be configured in one of four preprogrammed engineering units: per day, per hour, per minute, or per second. Users can specify decimal point position, from no decimal up to 0.001 of a unit, using the slide bar on the Turbine Input screen.

---

**Important:** If the volume portion of the Rate display is to be measured in user-defined units, the K-Factor unit must also be entered as “pulses per unit.” For more information, see [Entering a Calculated Divisor](#), page 29.

---

### Input Type/Sensitivity Configuration

The MC-III WP accepts either a turbine input or a pulse input. When the turbine input is selected, the user can also specify one of three sensitivity levels (low, medium, or high) to help minimize noise interference in the signal reception. A “low” sensitivity setting will detect a signal of approximately 20 mV peak-to-peak, while a “high” sensitivity setting will detect only signals that exceed 40 mV, peak-to-peak.

When a pulse input is selected, no sensitivity setting is required.

### Cut-Off Thresholds

Periods of very low or interrupted flow can lead to inaccuracies in indicated flow totals. To help prevent these inaccuracies, the user can establish cut-off thresholds to determine the minimum frequency and/or flow rate at which a signal will be recorded.

The flow rate cut-off is a setpoint for the accumulation of flow time in the hourly and daily records, and can be applied to either a turbine input or pulse input.

The frequency cut-off is reserved for the turbine input only. When the low-frequency cut-off is configured, the MC-III WP will ignore inputs that are less than the user-entered value.

### Calculation Period

The flow calculation period is the number of seconds that are allowed for calculating the flow condition. This setting is easily adjusted with the “plus” and “minus” buttons on the screen, or the page-up and page-down keys on your computer keyboard. Increasing this setting value results in flow rates with greater resolution. This setting is also the time allowed for processing of display updates.

## K-Factor Entry

The K-Factor Entry screen (Figure 4.22) allows users to calibrate the MC-III WP using a single calibration factor from a turbine flowmeter or multipoint linearization. Users can also configure the MC-III WP to compensate for the effect of pressure, temperature, and compressibility on gas volume measurements.

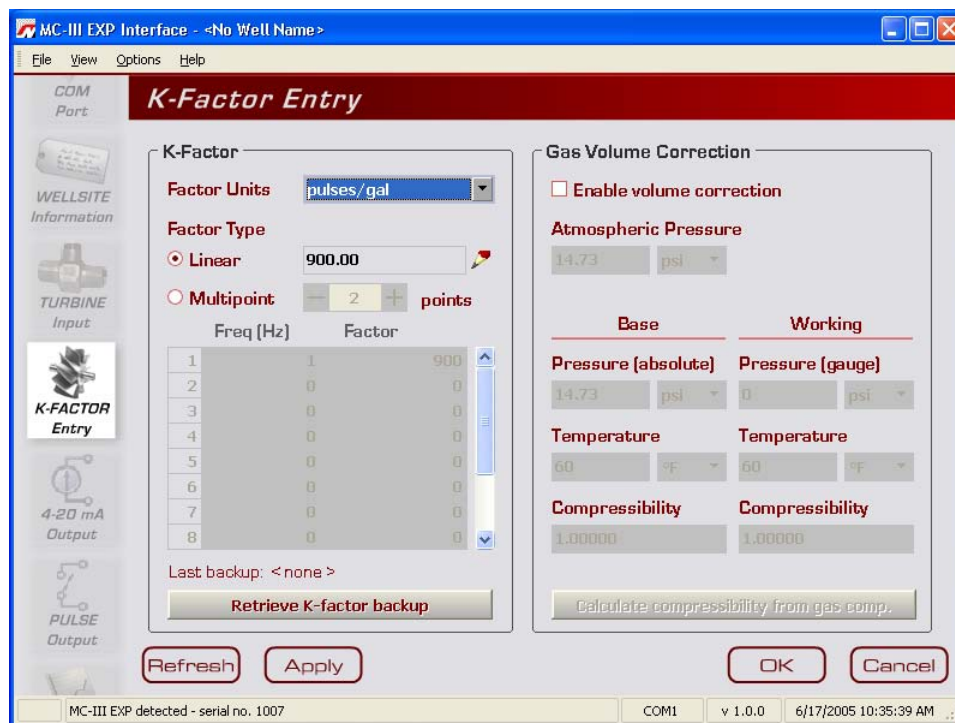

Figure 4.22—K-Factor Entry screen

### K-Factor Units

K-Factor entry consists of selecting the K-Factor unit and type (linear or multipoint). In selecting the unit, users can choose from five preprogrammed units (pulses per gallon, barrel, cubic meter, cubic foot, or liter). If a calculated divisor is to be used, “pulses per unit” should be selected.

### K-Factor Type

For linear calibration, the user need only select the Linear checkbox and enter the K-factor of the turbine meter. To enter the K-factor value, click on the pencil icon to open a data-entry window (Figure 4.23). Enter the digits, left to right, and adjust the slide bar to move the decimal point to the proper position.

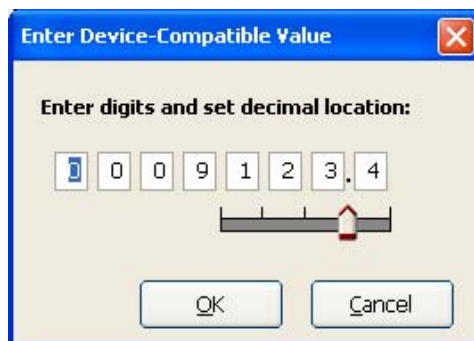

Figure 4.23—Data-entry screen for linear K-factor

For multipoint calibration, the user selects the Multipoint checkbox, and then enters the number of calibration points he desires using the “plus” and “minus” buttons on the screen or the page-up and page-down keys on a computer keyboard. Up to 12 calibration points may be entered. Frequency and factor data-entry fields are automatically activated for the number of calibration points selected. The user can then enter the appropriate data for each point.

### K-Factor Backup

Each time a calibration factor is entered or changed, the software prompts the user to copy the previous settings to backup memory (Figure 4.24). In the event that an error is made while entering configuration parameters, the user can restore the last saved set of configuration settings to the instrument.

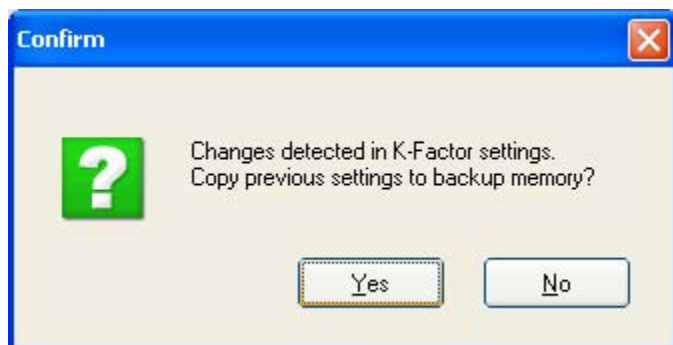

Figure 4.24—Prompt to copy previous calibration settings to backup

Select “yes” to save the previous calibration factor to memory. The date and time of this backup is displayed next to the “Retrieve K-Factor Backup” button on the K-Factor Entry screen. Only the last saved backup can be retrieved.

To retrieve the last saved K-Factor backup, perform the following steps:

1. Press the “Retrieve K-Factor Backup” button. A confirmation screen will appear with a prompt to proceed or terminate the retrieval.
2. Press “yes” to retrieve the last backup.
3. Click “OK” or “Apply” to save the retrieved settings to the configuration file. Because the retrieval of these settings represents a change to the current K-Factor settings, you will again be prompted to copy the previous settings to backup.

## Gas Volume Correction (Supercompressibility Calculation)

Gas turbine meters are calibrated in actual cubic feet (ACF), and measure gas in actual cubic feet. In some applications, a user may benefit from referencing gas measurements back to standard conditions by measuring in terms of standard cubic feet (SCF). The MC-III WP makes this process quick and easy, by using fixed average values for the flowing gas temperature and flowing gas pressure.

By default, this option is disabled.

To access this feature, check the “Enable volume correction” checkbox in the Gas Correction section of the K-Factor screen. The “STANDARD” annunciator on the LCD will illuminate, and all other Gas Volume Correction data fields will be activated (Figure 4.25).

The screenshot shows the 'K-Factor Entry' screen with the following settings:

- K-Factor:**
  - Factor Units: pulses/cf
  - Factor Type: Linear (125.21) / Multipoint (8 points)
  - Table:

Point	Freq (Hz)	Factor
1	100	125.21301
2	200	126
3	300	125.20001
4	400	125.34003
5	500	126
6	600	125.97
7	700	125.97
8	800	125.34
  - Last backup: 04/13/2005 11:42 AM
  - Buttons: Refresh, Apply
- Gas Volume Correction:**
  - Enable volume correction
  - Atmospheric Pressure: 14.73 psi
  - Base Pressure (absolute): 14.73 psi
  - Working Pressure (gauge): 100 psi
  - Base Temperature: 60 °F
  - Working Temperature: 90 °F
  - Base Compressibility: 0.99786
  - Working Compressibility: 0.98642
  - Buttons: Calculate compressibility from gas comp., OK, Cancel

Figure 4.25—Gas volume correction settings on K-Factor Entry screen

Atmospheric pressure is set at 14.73 psia by default, but can be adjusted to local conditions.

To compensate the gas measurement to standard conditions, complete the following steps:

1. Enter the atmospheric pressure.
2. Enter the base pressure and unit. The base pressure is the pressure to which the gas will be compensated (typically, 14.73 psia).
3. Enter the base temperature and unit. The base temperature is the temperature to which the gas will be compensated (typically, 60°F).
4. Enter the working pressure and unit. The working pressure is the user-entered pressure that represents the average working (flowing) pressure.
5. Enter the working temperature and unit. The working temperature is the user-entered temperature that represents the average working (flowing) temperature.

6. Enter a known compressibility factor, or press “Calculate compressibility from gas comp.” to view a selection of gas compositions (Figure 4.26).
  - To automatically calculate the compressibility factor, enter the gas composition and click on “Calculate.” The software will calculate flowing gas compressibility in accordance with the AGA-8 detail method.
  - The K-Factor Entry screen will reappear, and the calculated super-compressibility factor will be displayed.

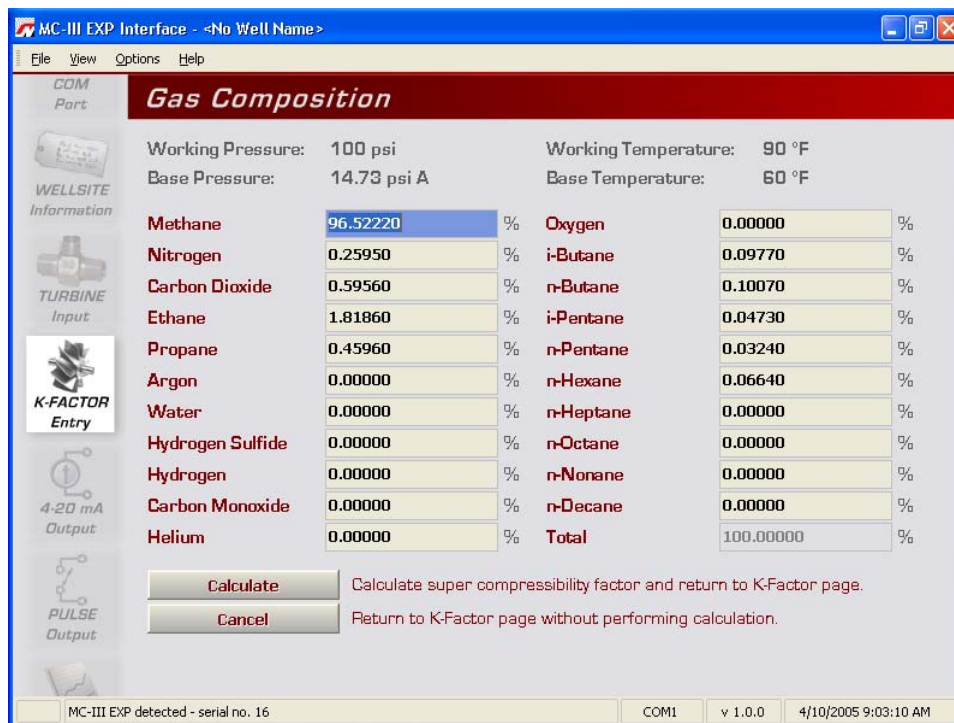

Figure 4.26—Gas Composition screen

## 4-20 mA Output

WARNING



Do not make or break any connections on the 4-20 mA current loop unless the area is known to be non-hazardous.

**Caution:** Before performing any 4-20 mA calibration, ensure that all peripheral equipment connected to the 4-20 mA current loop is either disconnected or disabled. Calibrating and testing the 4-20 mA output feature on the MC-III WP with the peripheral equipment in operation may cause false alarms or erroneous operation of the peripheral device or associated equipment.

The 4-20 mA Output screen (Figure 4.27) allows users to configure the MC-III WP to provide a 4-20 mA output representing flow rate. Zero and full-scale values can be configured to represent any flow rate range within the range of the flowmeter. A test mode function is also included, allowing a user to calibrate and/or verify the output received by an end device.



Figure 4.27—4-20 mA Output screen

The low (or zero) setting is the flow rate value that will produce a 4-mA output. The high (or full-scale) setting is the flow rate value that will produce a 20-mA output. Typically, the high value is greater than the low value; this scenario is defined as “direct mode” in [Figure 4.28](#), page 66.

Alternatively, users may configure the 4-mA and 20-mA outputs to have an inverse relationship, such that the high value is less than the low value. This scenario is defined as “indirect mode” in [Figure 4.28](#), page 66.

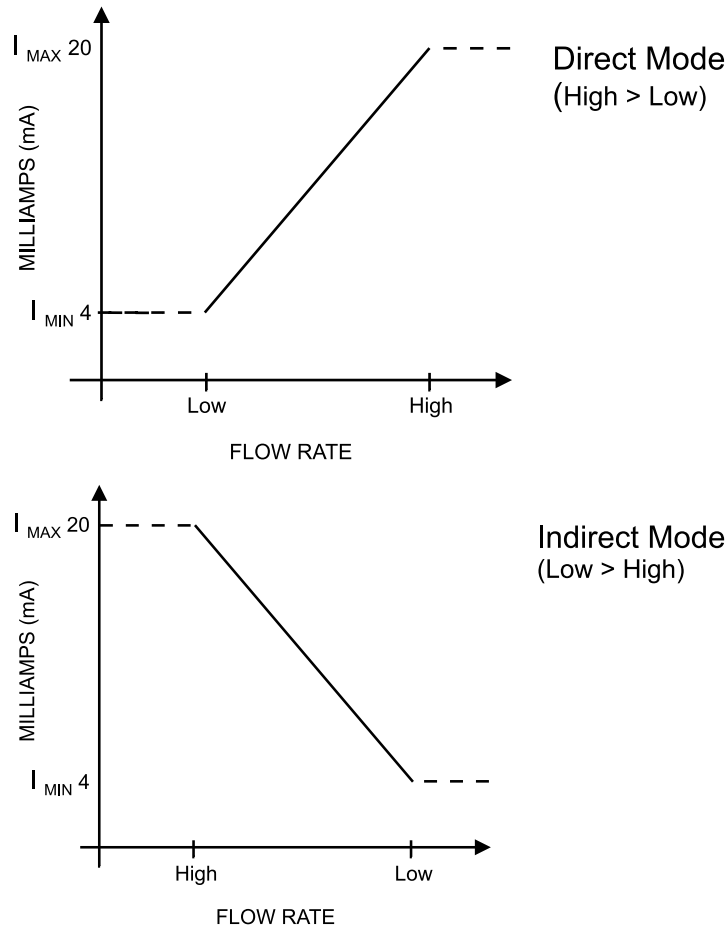

Figure 4.28—Two options for configuring a 4-20 mA output

Flow rates in-between the minimum and maximum rate setpoints will result in an output of current between 4 mA and 20 mA according to the following calculation:

$$I_{OUT} = \frac{[I_{MAX} - I_{MIN}]}{High - Low} \times [RATE_{CURR} - Low] + I_{MIN}$$

Where:

$I_{OUT}$  = output current

$I_{MAX}$  = maximum current output (20 mA)

$I_{MIN}$  = minimum current output (4 mA)

High = programmed flow rate that produces a 20-mA output

Low = programmed flow rate that produces a 4-mA output

$RATE_{CURR}$  = flow rate



### Enabling 4-20 mA Output

By default, the 4-20 mA output option is disabled. To enable this feature, perform the following steps:

1. Check the “Enable” checkbox.
2. Click on the pencil icon next to the Low Flow Rate field to launch a data-entry window (Figure 4.29) and enter the “low” or “zero” flow rate value that will produce a 4-mA output. Adjust the decimal position, if necessary, using the slide bar. A flow rate less than or equal to this minimum setpoint will result in an output of 4 mA.
3. Click on the pencil icon next to the High Flow Rate field and enter the “high” or “full-scale” flow rate value that will produce a 20-mA output. Adjust the decimal position, if necessary, using the slide bar. A flow rate equal to or greater than this maximum setpoint will result in an output of 20 mA.

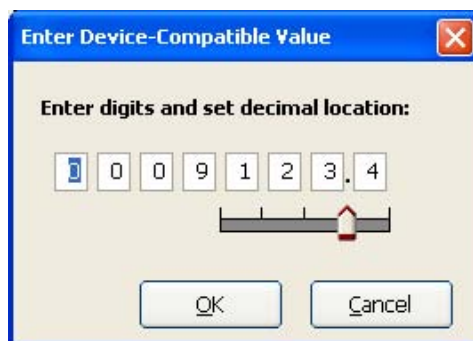

Figure 4.29—Data-entry screen for 4-20 mA low and high values

### 4-20 mA Output Testing

The MC-III software allows users to test the 4-20 mA output by entering an output current value and reading the live value generated in response.

To use the test mode, press the “Test 4-20 mA Output” button at the bottom of the 4-20 mA Output screen. The test page will appear (Figure 4.30, page 68), and the 4-20 mA Output option will be temporarily disabled.

To test the output, enter a value in the Output Current (mA) field, and press “Set Output.”

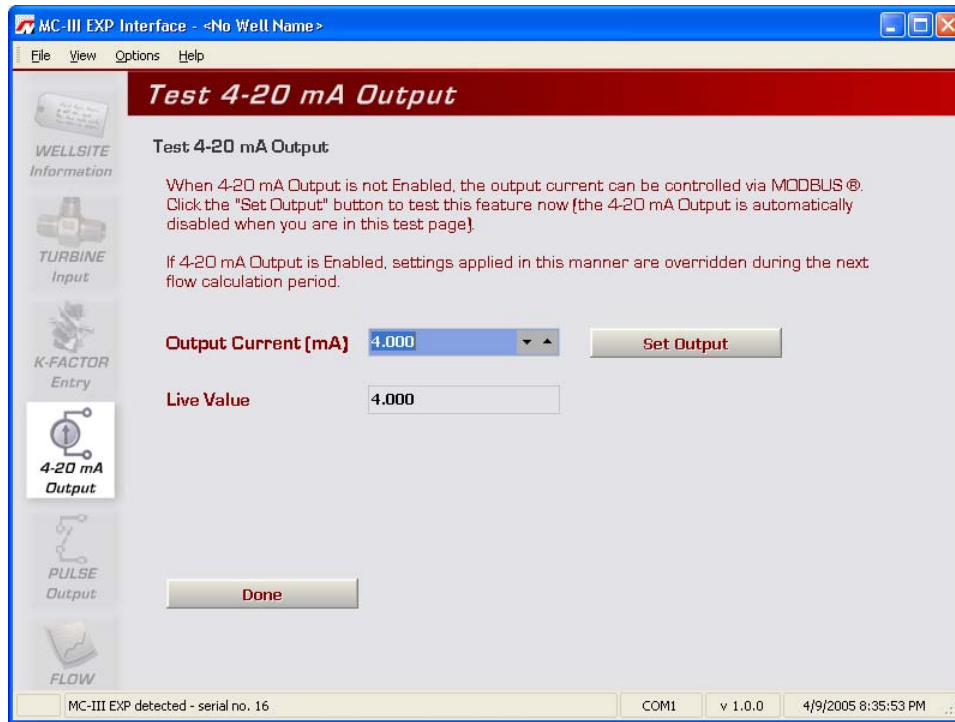

Figure 4.30—4-20 mA output test screen

## Pulse Output

The Pulse Output screen (Figure 4.31) allows users to configure the MC-III WP to provide a pulse output representing increments in volume. A test mode function is also included, allowing a user to calibrate and/or verify the output received by an end device.



Figure 4.31—Pulse Output screen

### Configuring Pulse Output

By default, the pulse output option is disabled to reduce current consumption. To conserve power, do not enable this feature unless it will be used.

To enable the pulse output option, perform the following steps:

1. Check the “Enable” checkbox.
2. Enter the pulse duration value using the “plus” and “minus” buttons on the screen, or the page-up and page-down keys on a computer keyboard. The pulse length (pulse width) determines the length of each output pulse in milliseconds (ms).
3. Click on the pencil icon next to the scale field to open a data-entry window (Figure 4.32), and enter the scale factor. Adjust the decimal position, if necessary, using the slide bar. The scale factor sets the volume increment that will cause a pulse output to occur. The unit for this factor is determined by the unit set for the volume display.

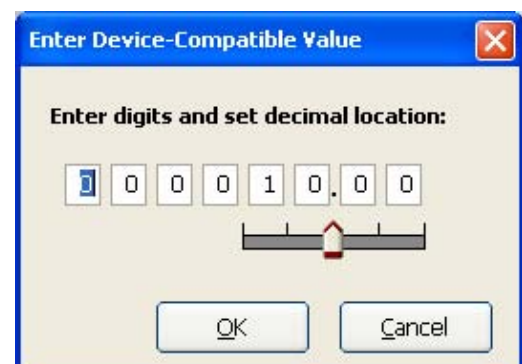

Figure 4.32—Data-entry screen for pulse output scale factor

---

Note: The scale factor can be any number; it is not limited to powers of 10 (1, 10, 100, etc.).

---

In applications where high flow rates may occur for extended periods, pulses can be lost due to the instrument's inability to register the flow rate at the maximum output frequency. To avoid the loss of pulses, users can raise the scale factor or shorten the pulse duration. The software calculates the maximum flow rate that can be reached before pulse caching is likely to occur, and displays the information on the Pulse Output screen. In applications where short bursts of high flow rates are common (separators, tank loading, dump cycles, etc.), the displayed flow rate can exceed the maximum flow rate for short periods without compromising the accuracy of the total represented by the pulse output.

## Pulse Output Testing

The MC-III software allows users to test the pulse output by writing a value to the pulse accumulator. Such tests can aid in troubleshooting problems with hardware compatibility, threshold settings, and pulse duration settings.

To use the test mode, press the “Test Pulse Output” button at the bottom of the Pulse Output screen. The test page will appear (Figure 4.33), and the Pulse Output option will be temporarily disabled.

To test the output, enter a value in the Pulse Count field, and press “Set Output.” The value in the Live Value field will decrement to zero in accordance with the programmed pulse duration.

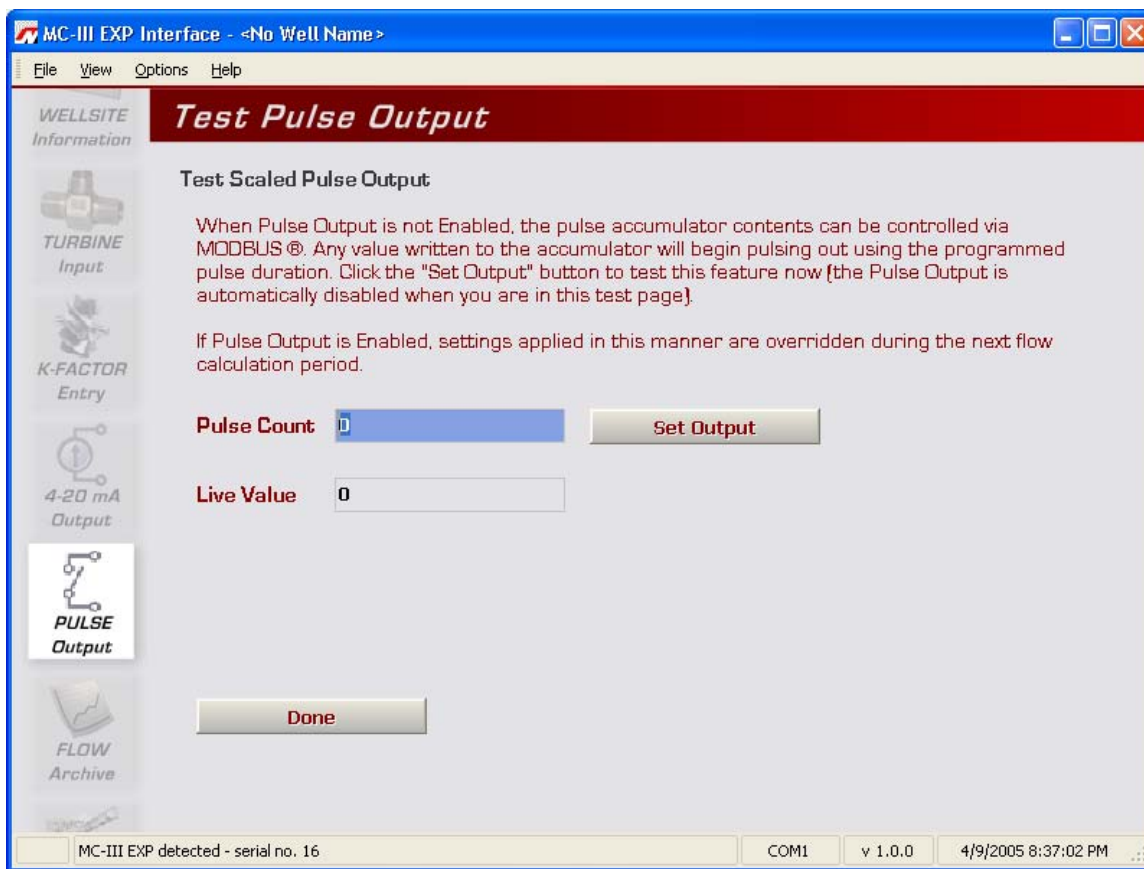

Figure 4.33—Pulse output test screen

## Saving and Uploading Configuration Files

The MC-III software allows a user to save configuration settings in a file that is stored on the user's computer and can be uploaded to the MC-III WP as needed. Configuration files are easily identified by the .mc3 extension. The default filename begins with "config" and uses the following structure:

File Format	Filename Structure
.mc3	"config"<date (YYMMDD)> <time (hhmmss)>.mc3 Example: config050209133922.mc3 is a configuration file that was downloaded on February 9, 2005 at 1:39:22 p.m.

### Saving a Configuration File

To save current configuration settings for future reference, perform the following steps:

1. Select File>Save Configuration File (Figure 4.34). A "Save MC3 Configuration File" screen will appear, prompting the user to save the file to the computer hard drive. The default directory is C:\NuFlo log data\MC-III\

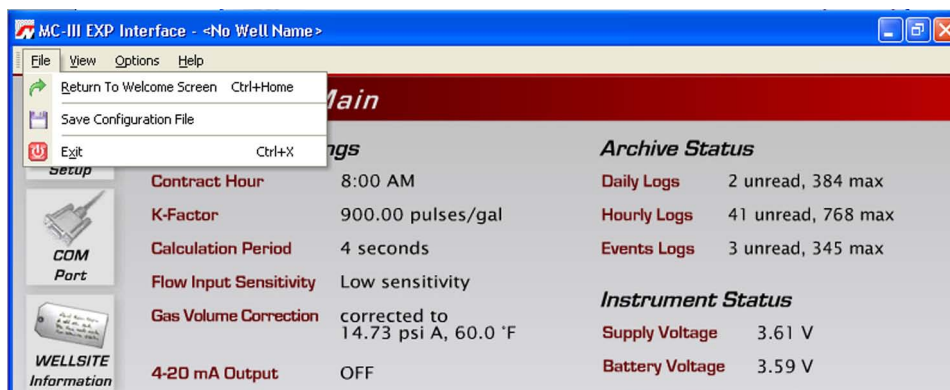

Figure 4.34—File dropdown menu allows user to save a configuration file

2. Click "Save." An "Information" window will appear to confirm that the file has been saved.

The "wellname" folder will bear the well name that appears on the Wellsite Information screen. If no well name is entered on this screen, the folder will be named "NO\_WELLNAME" (Figure 4.35, page 72).

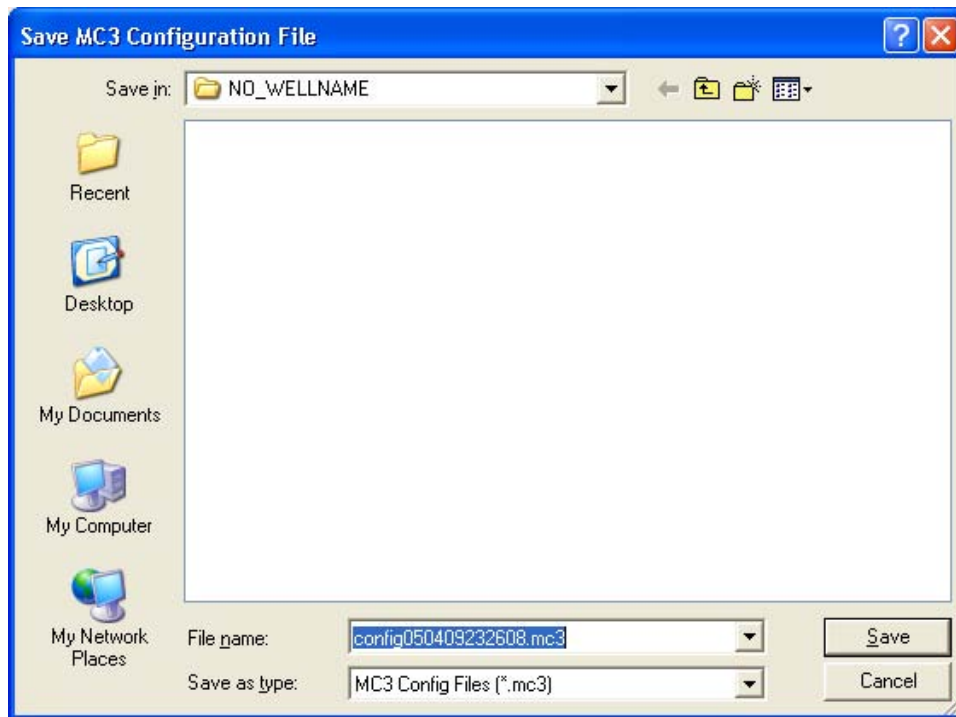

Figure 4.35—Default directory for configuration files

### Uploading a Configuration File

To upload a configuration file, perform the following steps:

1. From the Main screen, select File>Return to Welcome Screen (Figure 4.36).
2. Click on the LCD to connect to the MC-III WP.
3. Click “Upload a configuration” (Figure 4.37, page 73) and click “Do It Now.” A “Load MC3 Configuration File” window will appear (Figure 4.38, page 73), displaying the contents of the configuration folder.
4. Click on the appropriate well name folder, select the configuration file of your choice, and click “Open.” A “Progress” window will appear momentarily, followed by an “Information” window confirming the upload.



Figure 4.36—File dropdown menu allows user to return to the Welcome screen

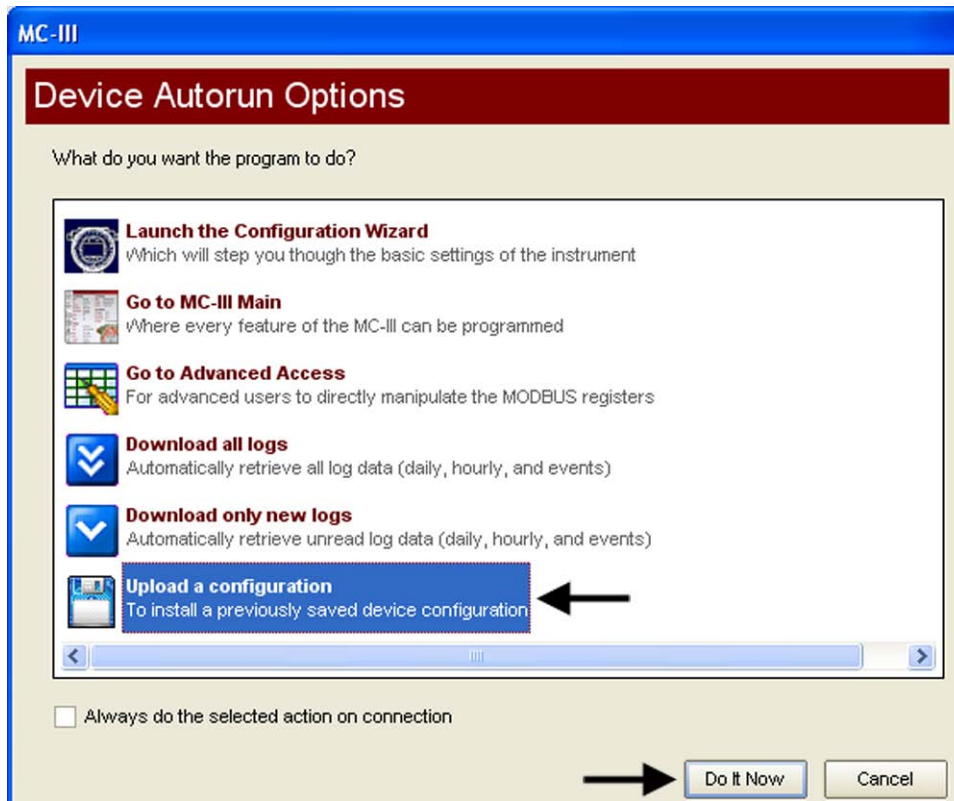

Figure 4.37—Upload a Configuration option

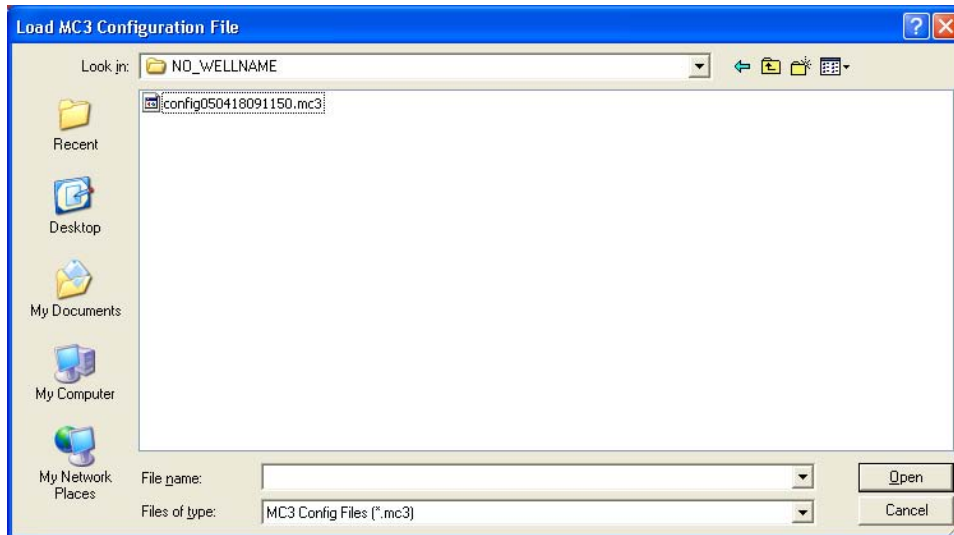

Figure 4.38—Default directory for configuration files

## Advanced Access

System configurators and host programmers can also access the software through the Advanced Access menu (Figure 4.39). This option provides access to the Modbus® registers for the MC-III WP. A series of tabs on the right side of the screen (real time, input configuration, output configuration...) allows the user to view a specific group of registers, or to view all registers in one list.

---

**Important:** The Advanced Access option is not required for the routine operation of the MC-III WP, and novice users should not access this portion of the software unless instructed to do so by Cameron technical support personnel.

---

Data retrieved from the MC-III WP while in Advanced access mode can be logged to a file by enabling the “Automatically log data polls” checkbox on the Advanced Options screen. The file will include values that are retrieved from the instrument when the user clicks the “Get All Data” button or enables “Auto Polling” on the Advanced Access screen. See also [Automatic Data Logging](#), page A-6.

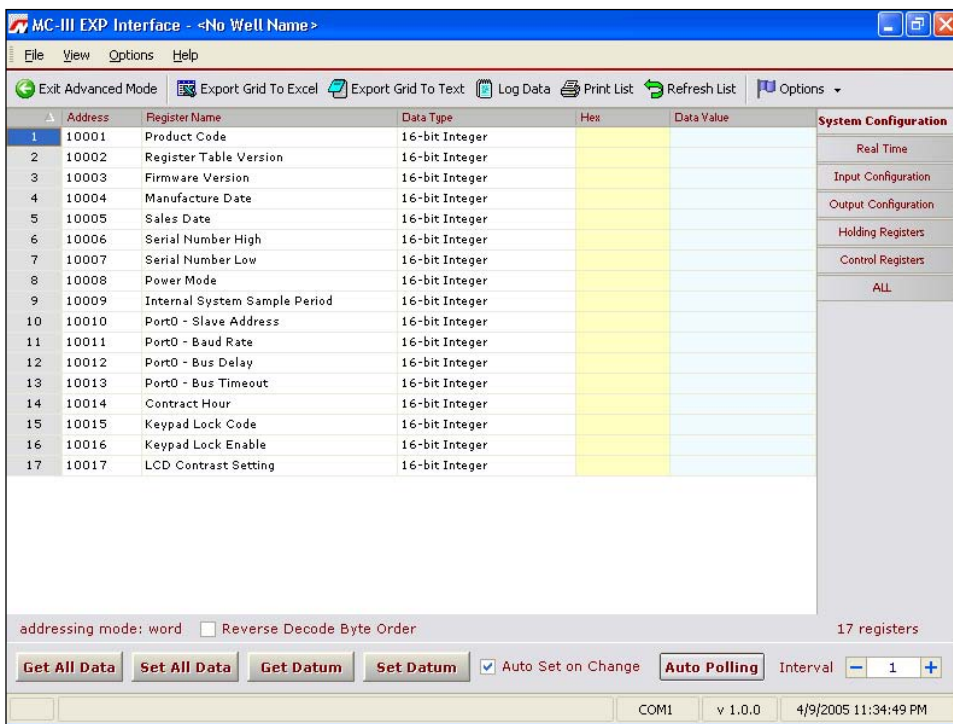

Figure 4.39—Advanced Access screen



## Section 5—Flow Logs and Event Logs

The MC-III™ WP's flow archive expands the user's ability to track flow volume over time by allowing the user to view flow data in tabular and trend formats, to save or print log data in reports, and to export log data into a spreadsheet. Additionally, an event archive allows users to identify changes to configuration parameters and other settings for troubleshooting operational issues.

A user can download logs from the Flow Archive and Event Archive screens as needed, or configure the software to automatically download the logs upon connection with the instrument. See [Automating Functions on Software Startup](#), page 41, for more information.

When the “download all logs” or “download only new logs” option is selected from the Device Autorun Options menu and the “Always do...” checkbox is checked, the software will download both flow logs and event logs each time the software connects to the MC-III WP (Figure 5.1).

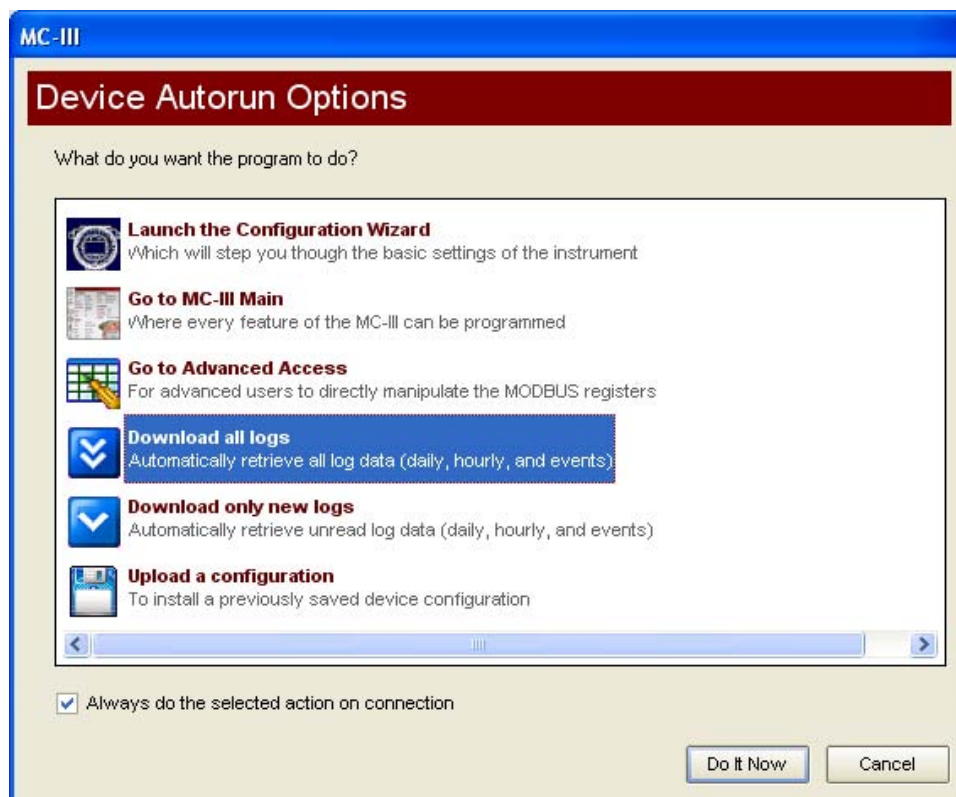

Figure 5.1—Device Autorun Options screen allows automated log downloads with every connection

## Auto-Save Log Formats

The MC-III WP automatically saves daily flow logs on the contract hour, and saves hourly flow logs around the clock. The instrument also automatically saves an event log each time a user change is made. After downloading these logs from the instrument, the software saves the data in a file. By default, the logs are saved as .csv files.

The file format of the auto-save flow log and event log files is user-configurable. To save logs in Excel (.xls) format, click Options>Program Options in the task bar, select Downloading from the dropdown options list, and check the “XLS-MS Excel File” checkbox (Figure 5.2).

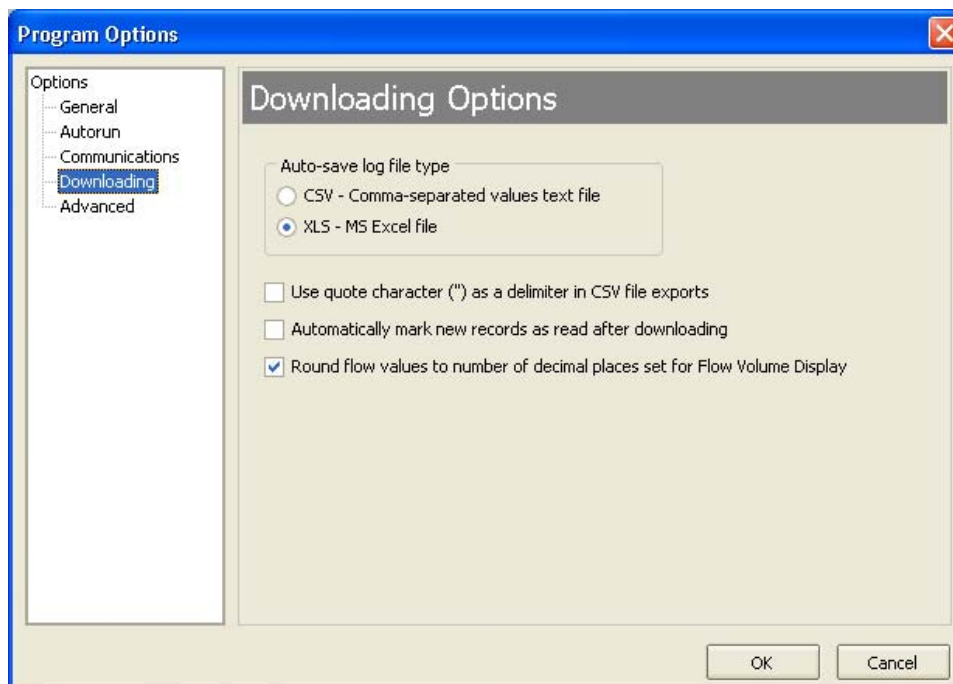

Figure 5.2—Log download options

## Log Directory and Filenames

Auto-save log files are saved in C:\NuFlo log data\MC-III<WELL NAME>. The “wellname” folder will bear the well name that appears on the Wellsite Information screen. If no well name is entered on this screen, the folder will be named “NO\_WELLNAME.”

Log filenames incorporate the serial number of the MC-III WP, the date, the time, and a capital letter indicating the log type, as shown below.

File Format	Filename Structure
.xls or .csv	<p>&lt;Serial number&gt;_&lt;date (YYYYMMDD)&gt;_&lt;time (hhmmss)&gt;_&lt;log type indicator&gt; where the log type indicator is “H” for hourly, “D” for daily, or “E” for event</p> <p>Example: 16_20050302_102031_H.xls is an hourly log file from the MC-III WP serial number 16 that was downloaded on March 2, 2005 at 10:20:31 AM.</p>

## Flow Archive

The MC-III WP automatically saves daily flow logs on the contract hour, and hourly flow logs. The Flow Archive screen (Figure 5.3) allows users to download, view, and print trend charts, and export daily and hourly logs. On the Flow Archive screen, users can view up to 384 daily logs and 768 hourly logs in tabular format (note the Daily Logs and Hourly Logs tabs at the bottom of the screen), or in a trend chart (see Daily Trend and Hourly Trend tabs).

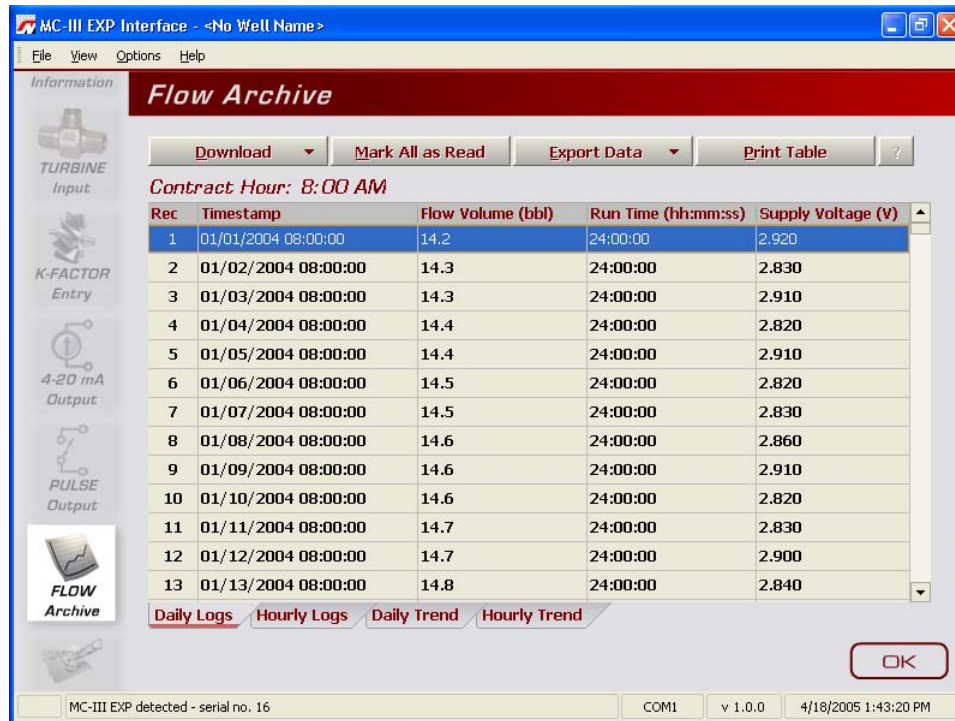

Figure 5.3—Flow Archive screen

### Downloading Flow Logs

To download flow logs, click the “Download” button on the Flow Archive screen, and select either Download All Flow Logs or Download Only New Flow Logs (Figure 5.4, page 78). (Download Only New Flow Logs will display only flow logs that have been created since the last download was performed.) Tabular views of the archive record (Figure 5.5, page 78) include a time stamp showing the exact time each log was recorded, as well as flow volume, run time, and supply voltage. Trend views (Figure 5.6, page 79) show the flow volume and time stamp only.

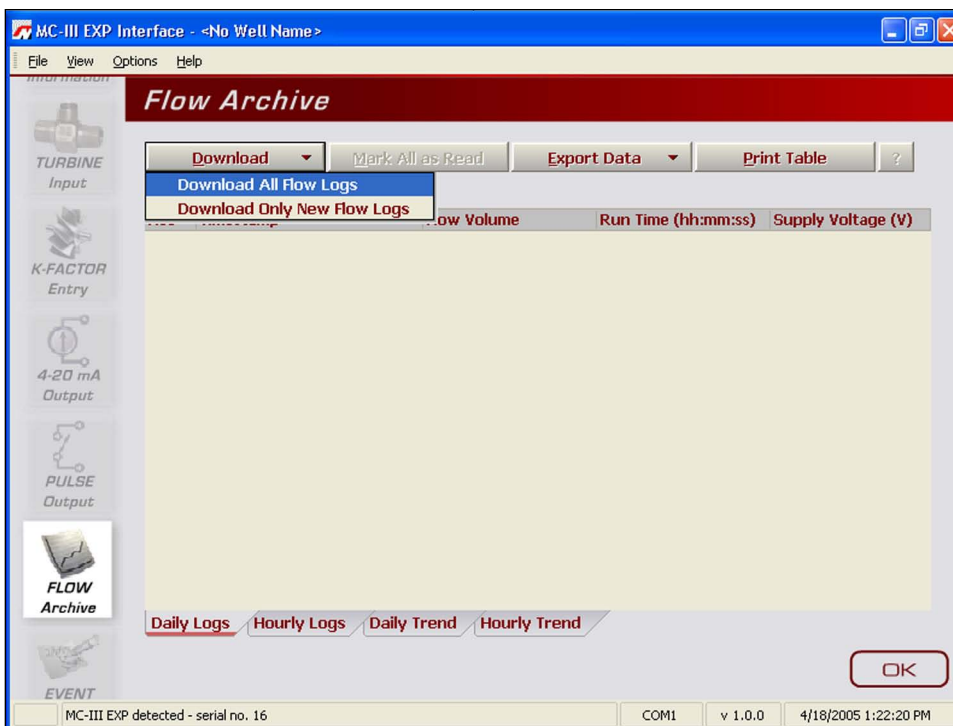

Figure 5.4—Menu for downloading flow logs from the Flow Archive screen

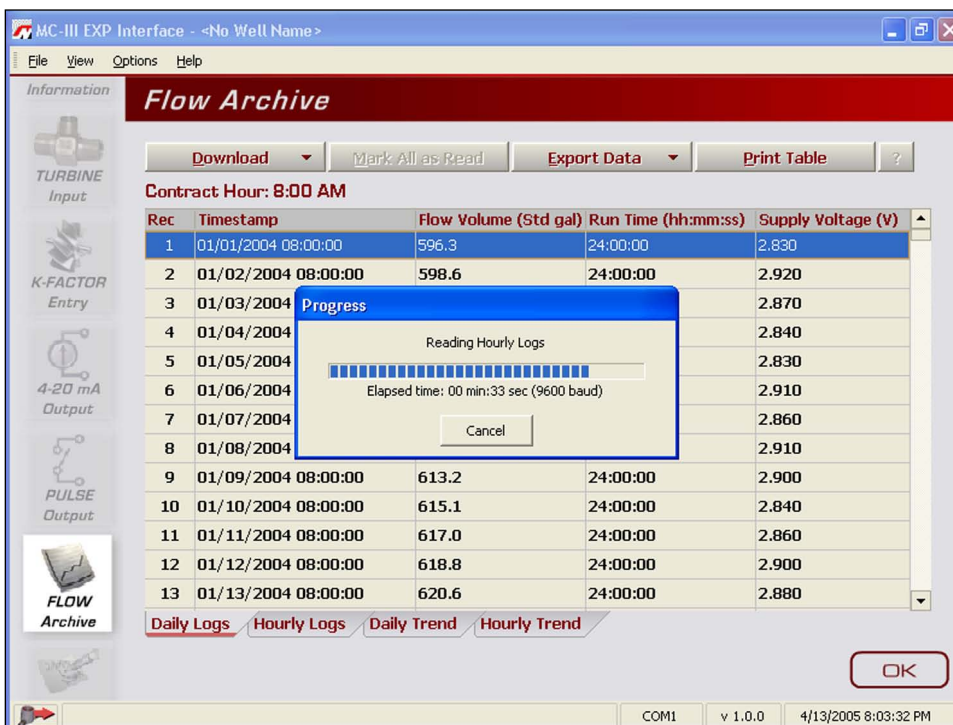

Figure 5.5—Downloaded flow logs (tabular view)

## Viewing Trend Charts

In the daily and hourly trend views, flow volumes are charted on a grid, with flow record numbers forming the horizontal axis, and flow volumes shown on the vertical axis. A graphical line defined by two yellow endpoints represents the range of archived logs available for viewing. A yellow triangle marks the first record, and a yellow circle marks the final record. The arrowhead cursor is paired with a dotted circle. As the user drags the cursor across the chart, the circle's position corresponds with the record displayed at the top of the screen (Figure 5.6). The circle's snap function allows the user to pinpoint transitional points within the trend display; the greater the zoom, the more precise the navigation.

---

**Important: The interactive cursor cannot be turned off.**

---

- To zoom in, left-click and drag the mouse to the right and down.
- To zoom out, drag the mouse up and to the left.
- To reposition the chart within the viewing window, right-click the chart and move the mouse slowly in any direction.
- To exit the page and return to the Main screen, press OK.

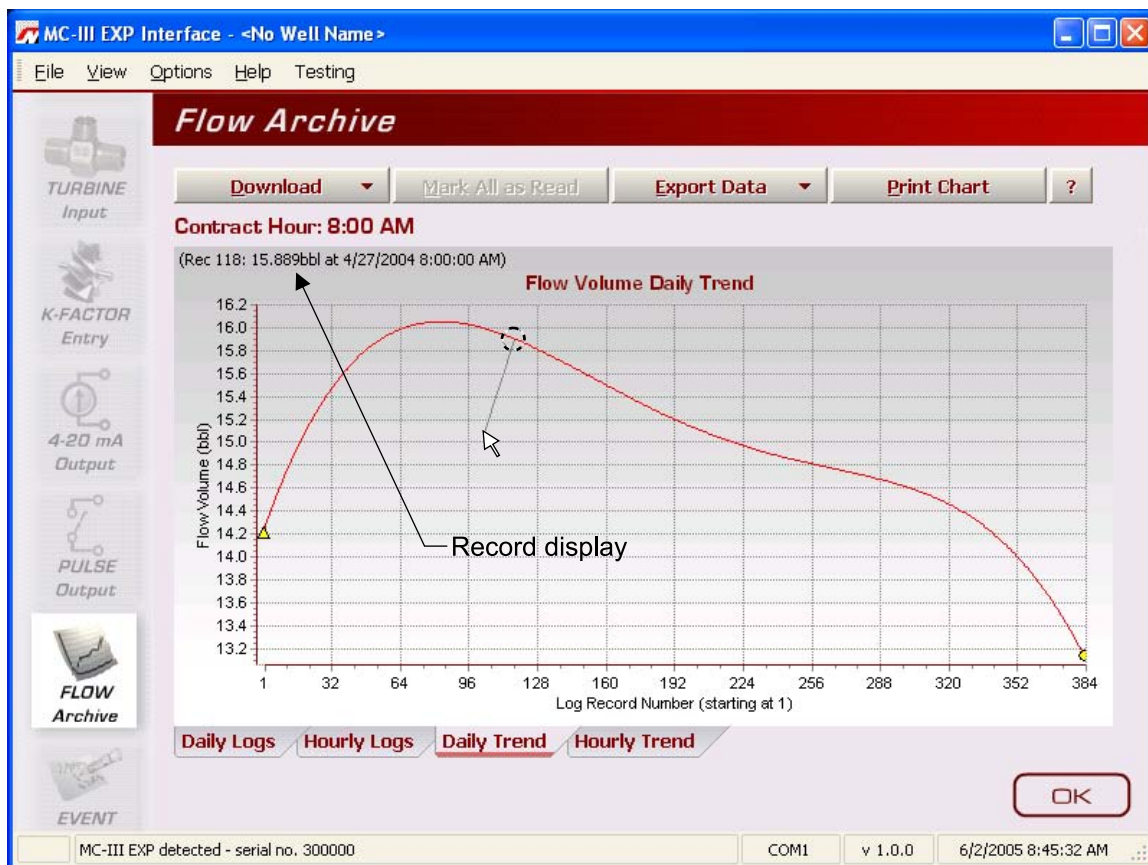

Figure 5.6—Flow Archive screen, trend view

## Printing/Saving a Report

A flow log can be printed and/or saved as a table (Figure 5.7, page 80) or a trend chart (Figure 5.8, page 81).

To print a log, select the appropriate tab at the bottom of the Flow Archive screen, and press the “Print” button in the upper right corner of the Flow Archive screen. (If the display is tabular, the button will read

“Print Table”; if the display is a chart, the button will read “Print Chart.”) A Print Preview screen will appear, displaying the image to be printed.

To print the report, select File>Print from the task bar (Figure 5.7).

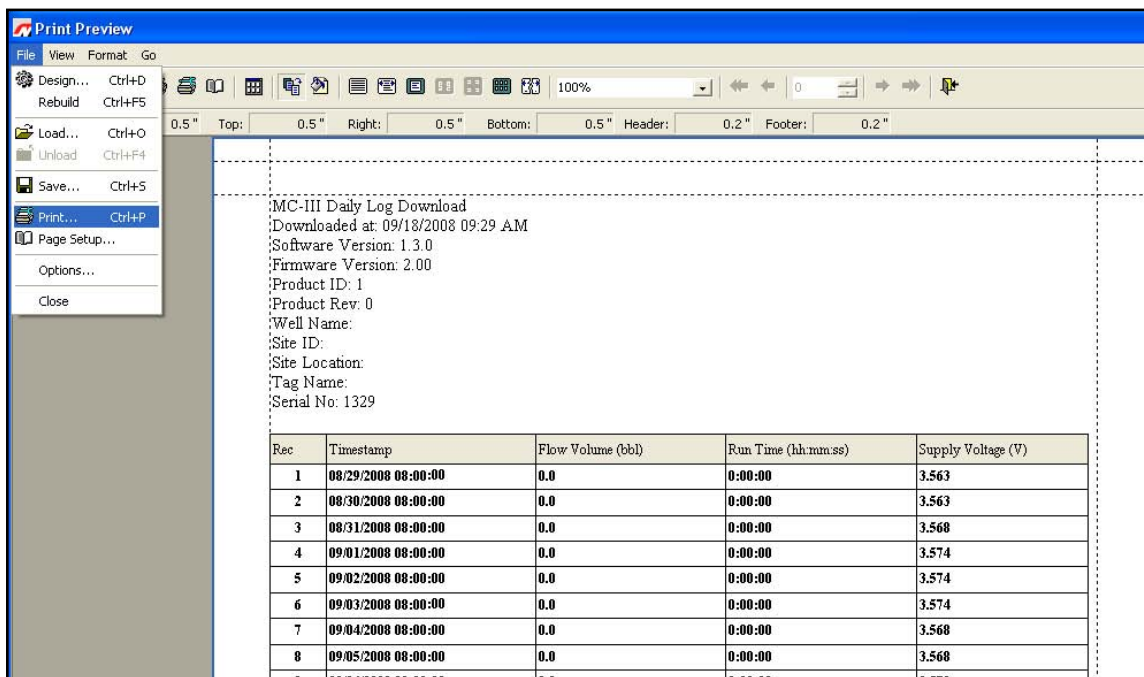

Figure 5.7—Print preview, tabular view

To save the report, perform the following steps:

1. Select File>Save from the task bar (Figure 5.8, page 81). A “Save Report As” window will open (Figure 5.9).
2. Enter a filename. The filename extension will be .rps.
3. Click “Save.” By default, log archive reports are saved in C:\NuFlo log data\MC-III<WELL NAME>, however the user can specify a new location, if desired. The “wellname” folder will bear the well name that appears on the Wellsite Information screen. If no well name is entered on this screen, the folder will be named “NO\_WELLNAME.”

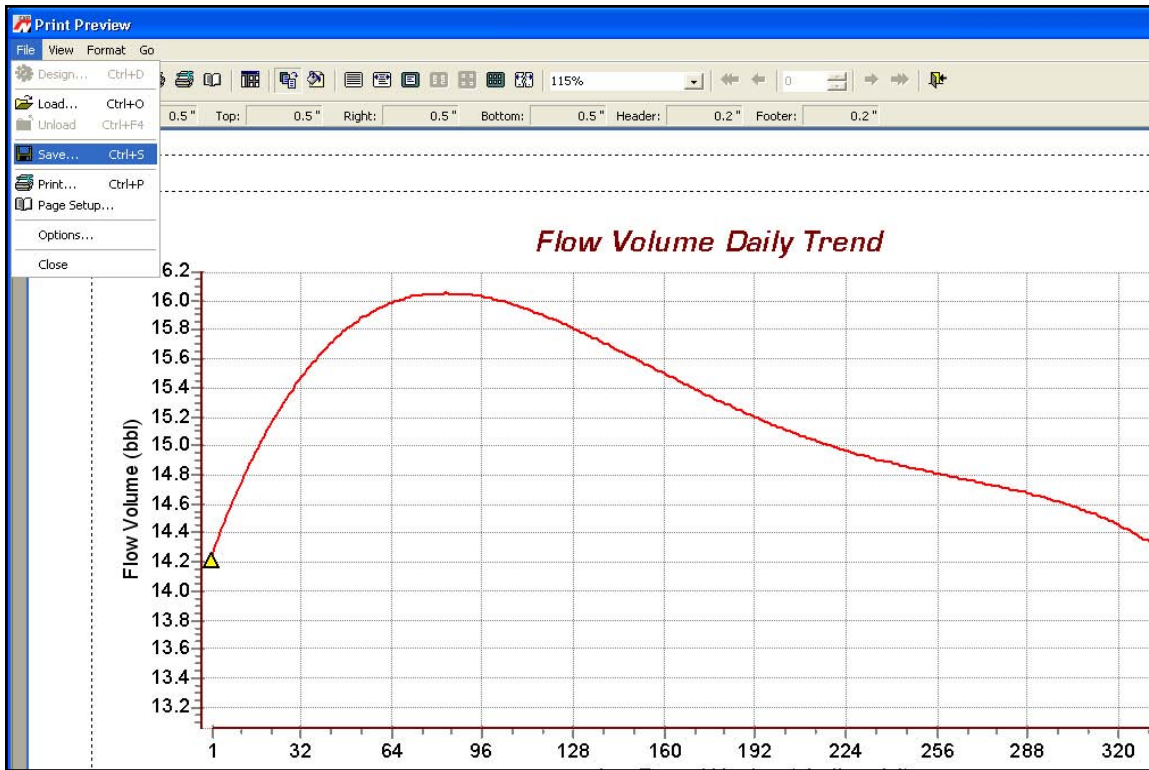

Figure 5.8—Print preview, trend view

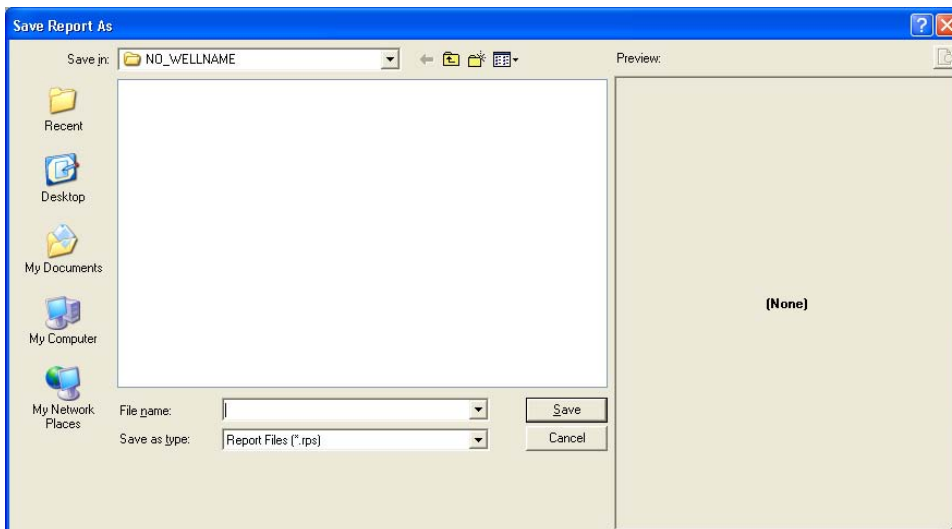

Figure 5.9—Save Report As screen

### Viewing a Saved Report

To view a saved report, perform the following steps:

1. From the Flow Archive screen, click “Print Table” (or “Print Chart” for trend chart views) in the upper right corner of the screen.
2. Select File>Load from the task bar at the top of the page (Figure 5.10, page 82). A Load Report window will open (Figure 5.11, page 82).

3. Click on the report you wish to view. A preview of the report will appear in the right portion of the window.
4. Click “Open.”

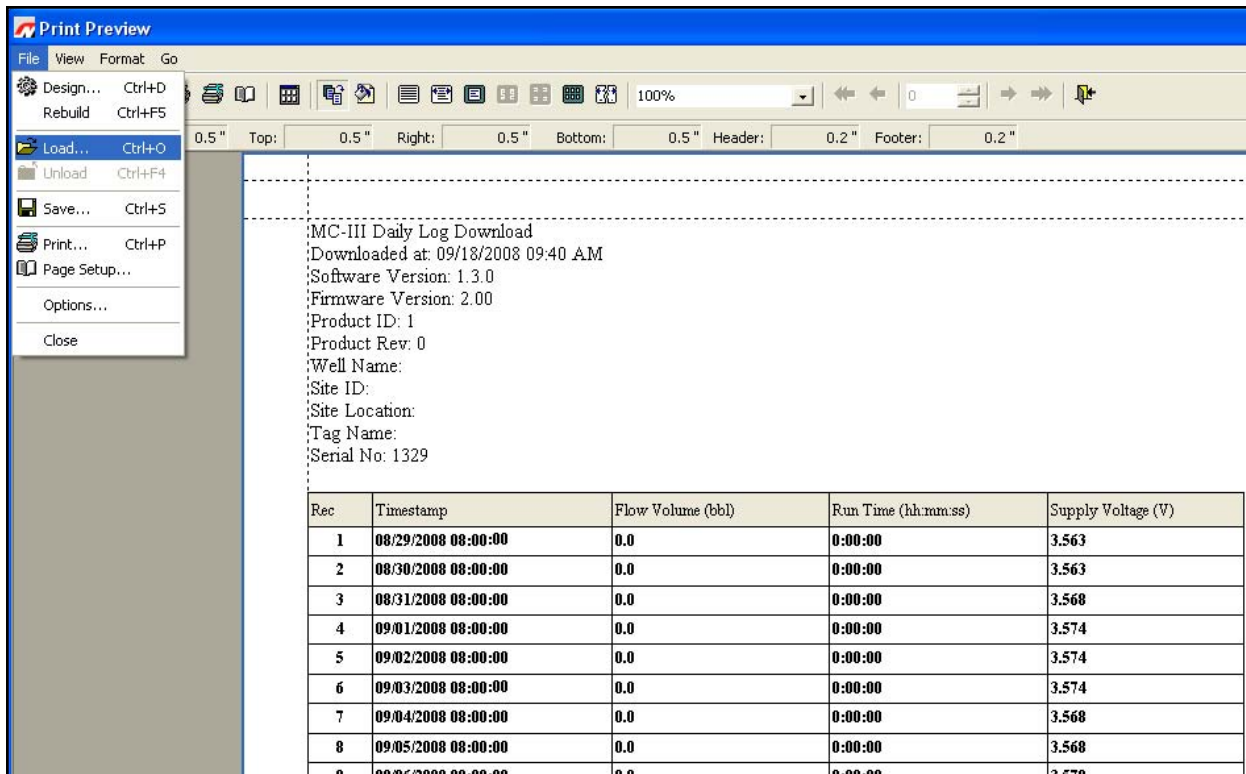

Figure 5.10—Menu for loading a saved report

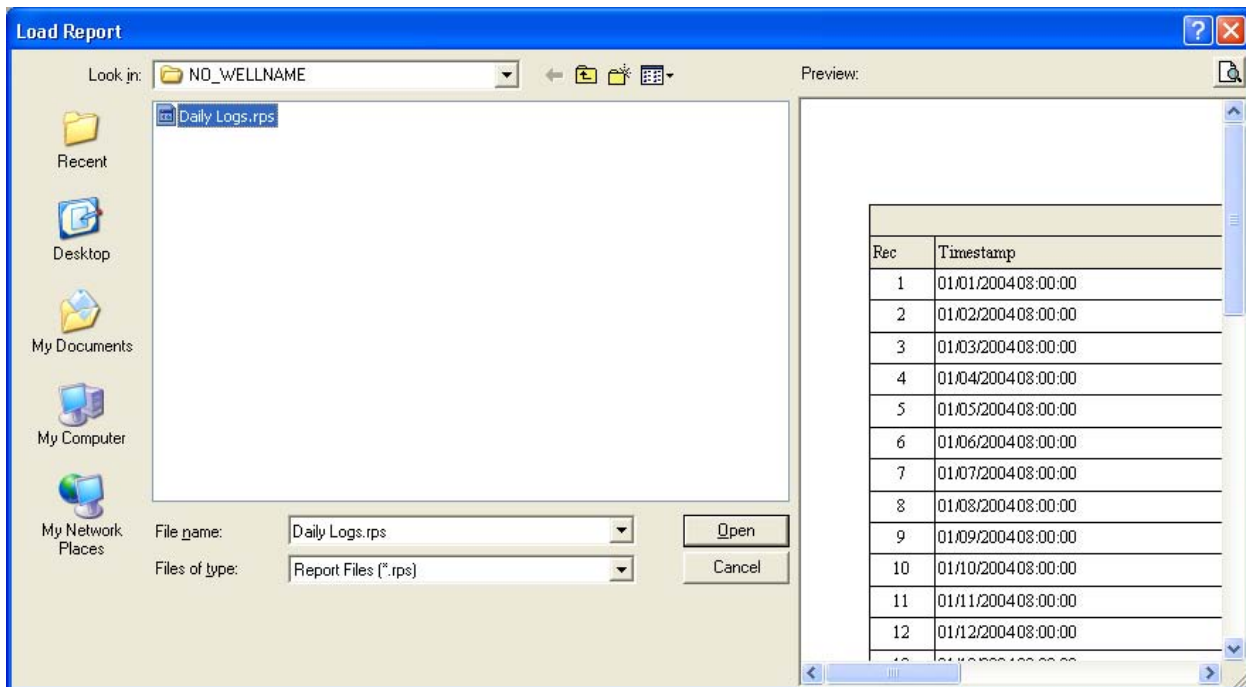

Figure 5.11—Load Report screen for viewing saved flow log reports



## Exporting Flow Logs

Flow logs can be directly exported to an .xls or .csv file for ease in viewing and distributing. To export a file, perform the following steps:

1. Click the “Export Data” button near the top of the Flow Archive screen and select the .xls or .csv format (Figure 5.12).
2. When the “Export Daily (or Hourly) Log Data...” window appears, click “Save.” By default, exported logs are saved in C:\NuFlo log data\MC-III<WELL NAME>, however the user can specify a new location, if desired ([Figure 5.13](#), page 84). The “wellname” folder will bear the well name that appears on the Wellsite Information screen. If no well name is entered on this screen, the folder will be named “NO\_WELLNAME.”

---

**Important:** Users can also specify the file format to be used for all auto-save logs (.csv or .xls). To change the auto-save format, follow the procedure described in [Downloading Options](#), page A-5.

---

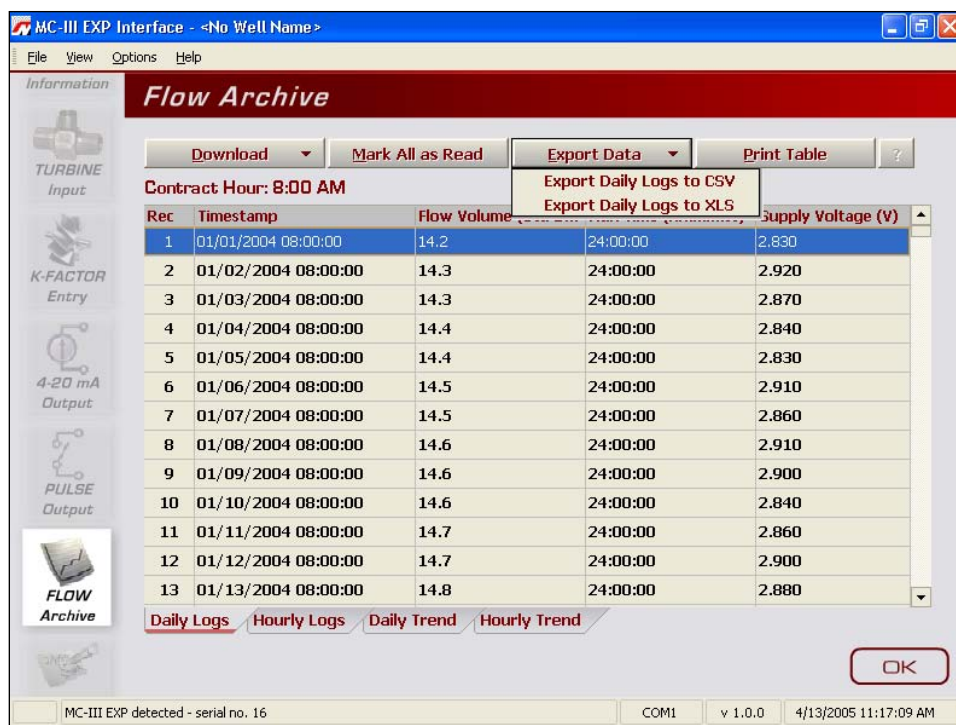

Figure 5.12—Dropdown menu for exporting log data

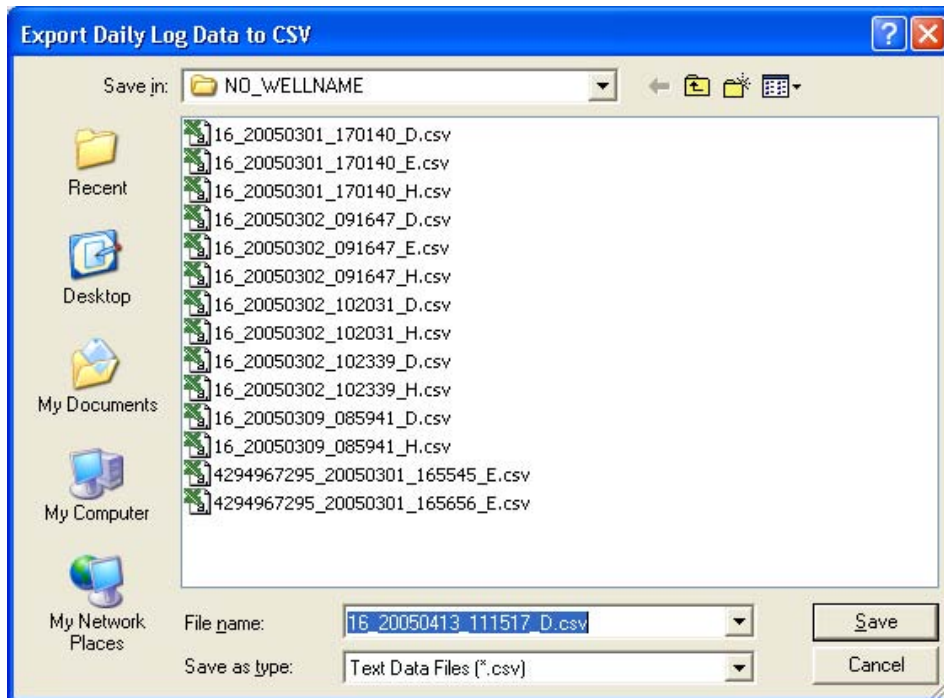

Figure 5.13—Default directory for exported log files

## Event Archive

The Event Archive screen (Figure 5.14) allows users to download, view, export, and print up to 345 user event logs. Event logs are generated to track user changes such as K-Factor changes, input setting changes, power-on and “watch-dog” resets, and the flow and frequency cut-off settings.

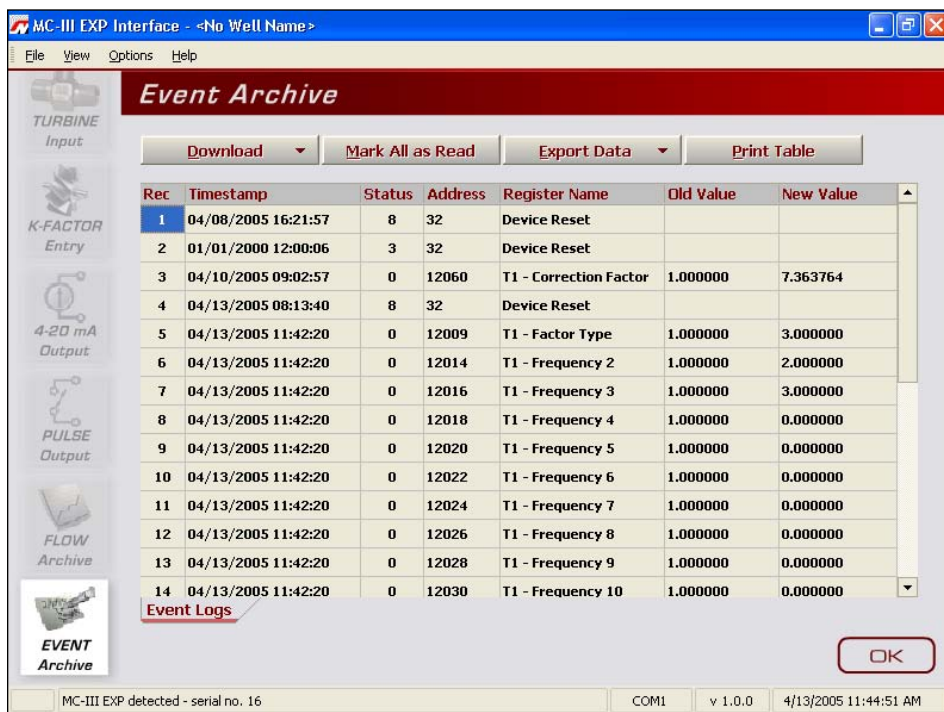

Figure 5.14—Event Archive screen

## Downloading Event Logs

To download event logs, click the “Download” button on the Flow Archive screen, and select either Download All Event Logs or Download Only New Event Logs, (Figure 5.15). (Download Only New Event Logs will display only flow logs that have been created since the last download was performed.) Tabular views of the archive record (Figure 5.16, page 86) include a time stamp showing the exact time each log was recorded, as well as the name of the register changed, and the old and new values assigned to that register.

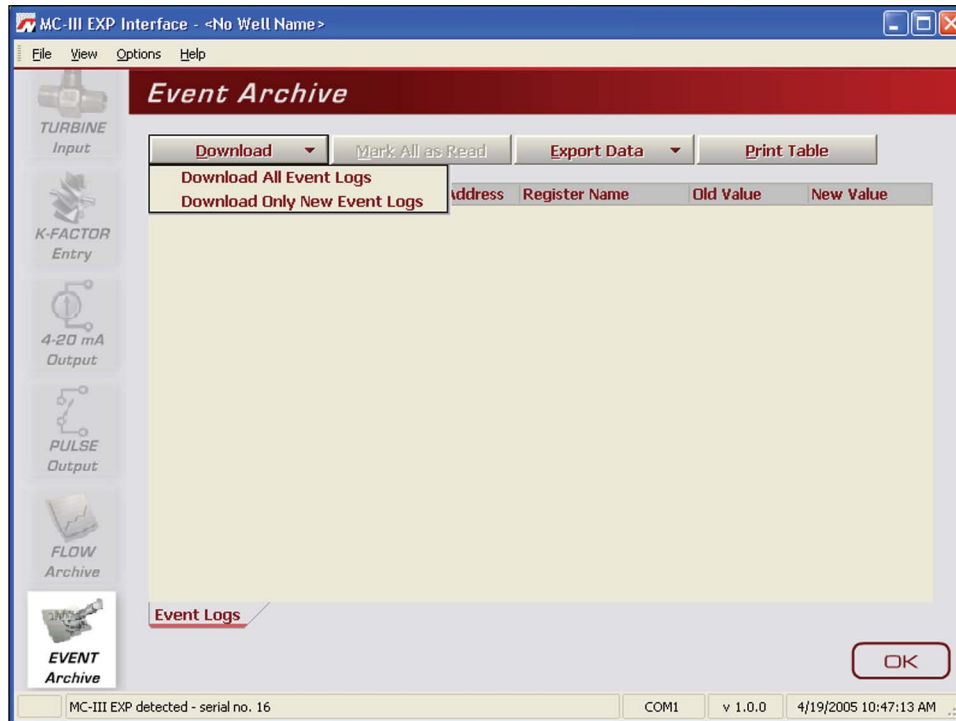

Figure 5.15—Menu for downloading event logs from Event Archive screen

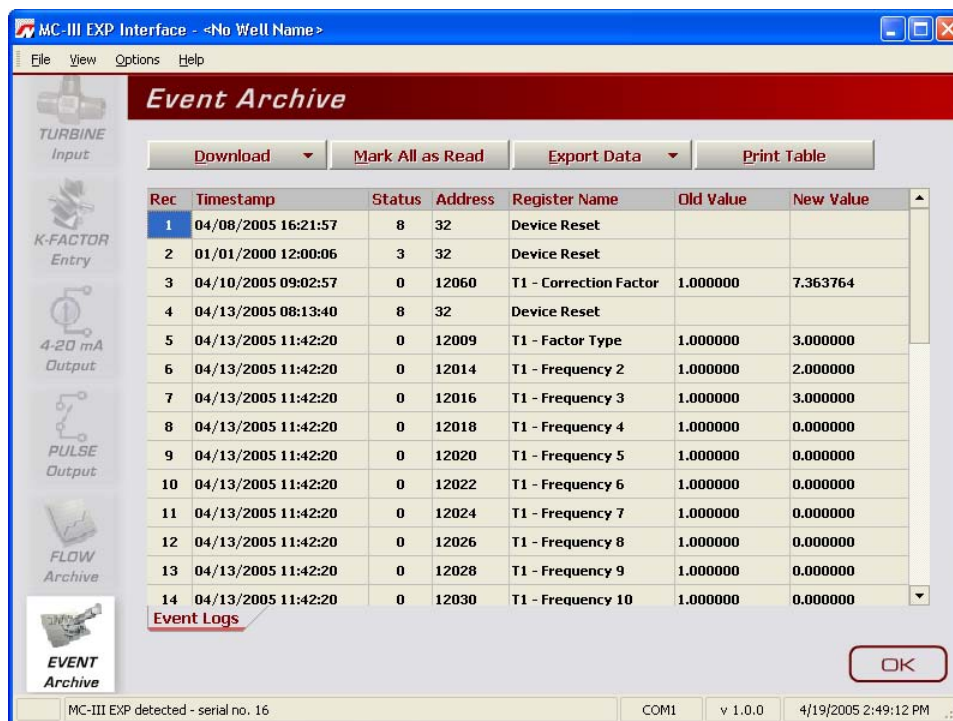

Figure 5.16—Downloaded event logs

### Printing/Saving a Report

To print an event log, press the “Print Table” button in the upper right corner of the Event Archive screen. A Print Preview screen will appear, displaying the image to be printed.

To print the report, select File>Print from the task bar.

To save the report, perform the following steps:

1. Select File>Save from the task bar. A “Save Report As” window will open.
2. Enter a filename. The filename extension will be .rps.
3. Click “Save.” By default, log archive reports are saved in C:\NuFlo log data\MC-III<WELL NAME>, however the user can specify a new location, if desired. The “wellname” folder will bear the well name that appears on the Wellsite Information screen. If no well name is entered on this screen, the folder will be named “NO\_WELLNAME.”

The procedure for printing and saving an event log report is nearly identical to the procedure for printing and saving a flow log report. See the flow log screen captures, [pages 80 through 82](#), for reference.

### Exporting Event Logs

Event logs can be directly exported to an .xls or .csv file for ease in viewing and distributing. To export a file, perform the following steps:

1. Click the “Export Data” button near the top of the Event Archive screen and select the .xls or .csv format ([Figure 5.17](#), page 87).

- When the “Export Event Logs...” window appears, click “Save.” By default, exported logs are saved in C:\NuFlo log data\MC-III\<WELL NAME>, however the user can specify a new location, if desired. The “wellname” folder will bear the well name that appears on the Wellsite Information screen. If no well name is entered on this screen, the folder will be named “NO\_WELLNAME.”

**Important:** Users can also specify the file format to be used for all auto-save logs (.csv or .xls). To change the auto-save format, follow the procedure described in [Downloading Options](#), page A-5.

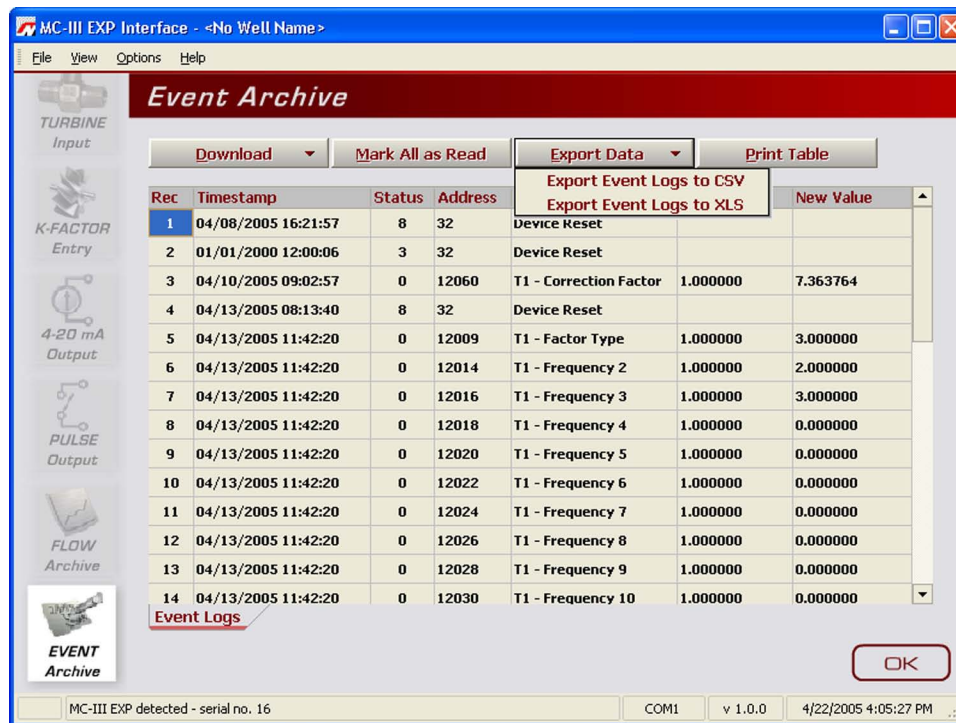

Figure 5.17—Dropdown menu for exporting log data



## Section 6 - MC-III WP Maintenance

The MC-III™ WP is designed to provide many years of service with minimal maintenance. Batteries require periodic replacement, and battery life depends on whether battery power is the primary or secondary power source.

All configuration settings are stored in nonvolatile memory; therefore, configuration settings will not be lost in the event of battery failure.

The circuit assembly or keypad may also require replacement over the life of the instrument. Procedures are provided in this section.

### Lithium Battery Replacement

The MC-III WP uses a lithium battery with a life expectancy of approximately 2 years. Due to the flat discharge characteristics of the lithium battery, it is difficult to determine how much life remains in a battery at any given time. To preserve configuration and accumulated volume data, replace the battery at 2-year intervals.

---

**WARNING**

**Do not attempt the replacement of the lithium battery unless the area has been declassified or is known to be non-hazardous.**

---

---

**WARNING**

**The lithium battery that powers the MC-III WP is a sealed unit; however, should a lithium battery develop a leak, toxic fumes could escape upon opening the enclosure. Ensure that the instrument is in a well-ventilated area before opening the enclosure to avoid breathing fumes trapped inside the enclosure. Exercise caution in handling and disposing of spent or damaged batteries. See additional information on lithium batteries in [Appendix B](#) of this manual.**

---

**Important:** **Press the ENTER/SAVE key on the keypad before replacing the lithium battery to save the accumulated total to nonvolatile memory. Once the battery is replaced and power is restored to the unit, the last saved accumulated total will be displayed in the LCD.**

---

The lithium battery is secured inside the enclosure by a velcro strap and connected to the circuit assembly via connector J1.

To replace the lithium battery in the MC-III WP, perform the following steps:

1. Open the door of the enclosure to access the lithium battery.
2. Loosen the velcro strap, disconnect the battery from the connector J1 on the circuit assembly, and remove the battery from the enclosure ([Figure 6.1](#), page 90). Send the depleted battery to a fully permitted Treatment, Storage and Disposal Facility (TSDF) or to a permitted recycling/reclamation facility, as required by federal regulations (see [Appendix B](#)).
3. Install the new battery in the enclosure in the same position as the original battery, and secure the velcro strap tightly around the battery.
4. Connect the replacement battery to the J1 connector on the circuit assembly.

5. Close the door of the enclosure and secure the latches.

---

**Important:** The interruption of power to the MC-III WP will cause the internal clock time to be inaccurate. Reset the time via the interactive software. See [Time/Date Synchronization](#), page 54.

---

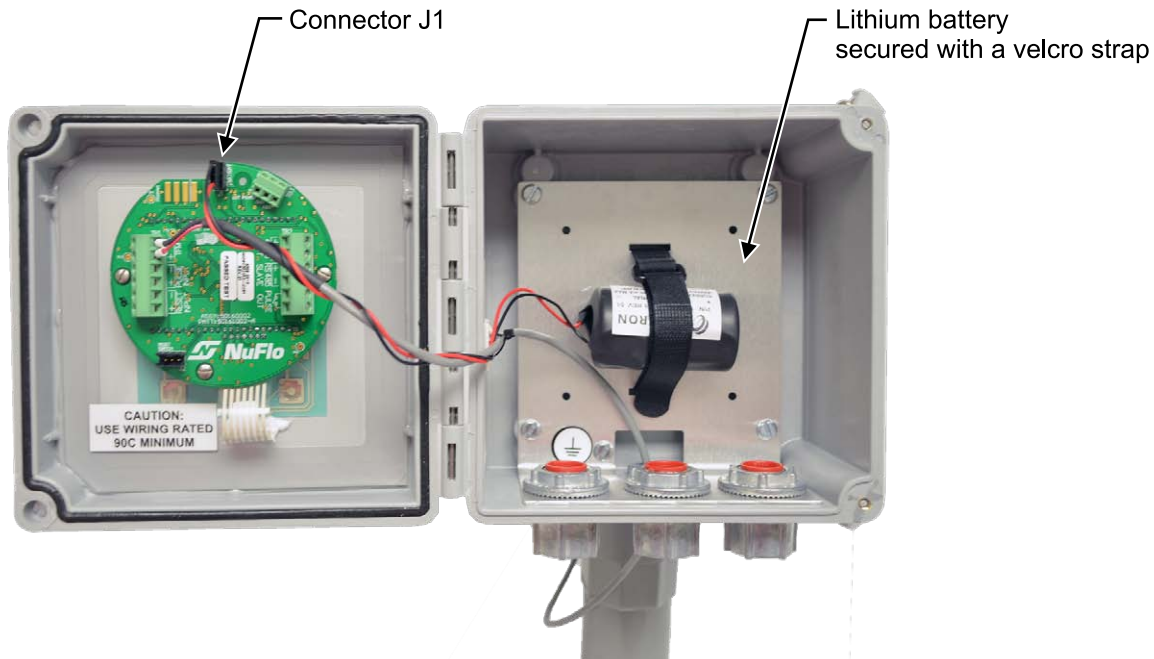

Figure 6.1—Lithium battery replacement

## Alkaline Battery Replacement

The alkaline battery powered instrument features a battery holder containing three D-size alkaline batteries. The batteries will require periodic replacement. The dimming of the LCD may be an indicator that battery power is diminishing, and the batteries should be replaced.

### WARNING



**Do not attempt the replacement of the alkaline batteries unless the area has been declassified or is known to be non-hazardous.**

---

**Important:** Press the ENTER/SAVE key on the keypad before replacing the alkaline batteries to save the accumulated total to nonvolatile memory. Once the batteries are replaced and power is restored to the unit, the last saved accumulated total will be displayed in the LCD.

---

The alkaline batteries and battery holder are secured inside the MC-III WP enclosure by a velcro strap and the battery holder is connected to the circuit assembly via connector J1.

To replace the alkaline batteries, perform the following steps:

1. Open the door of the enclosure to access the alkaline battery holder.
2. Loosen the velcro strap and disconnect the battery holder from connector J1 on the circuit assembly.



3. Remove the spent batteries from the holder (Figure 6.2) and dispose of them in accordance with local regulations.

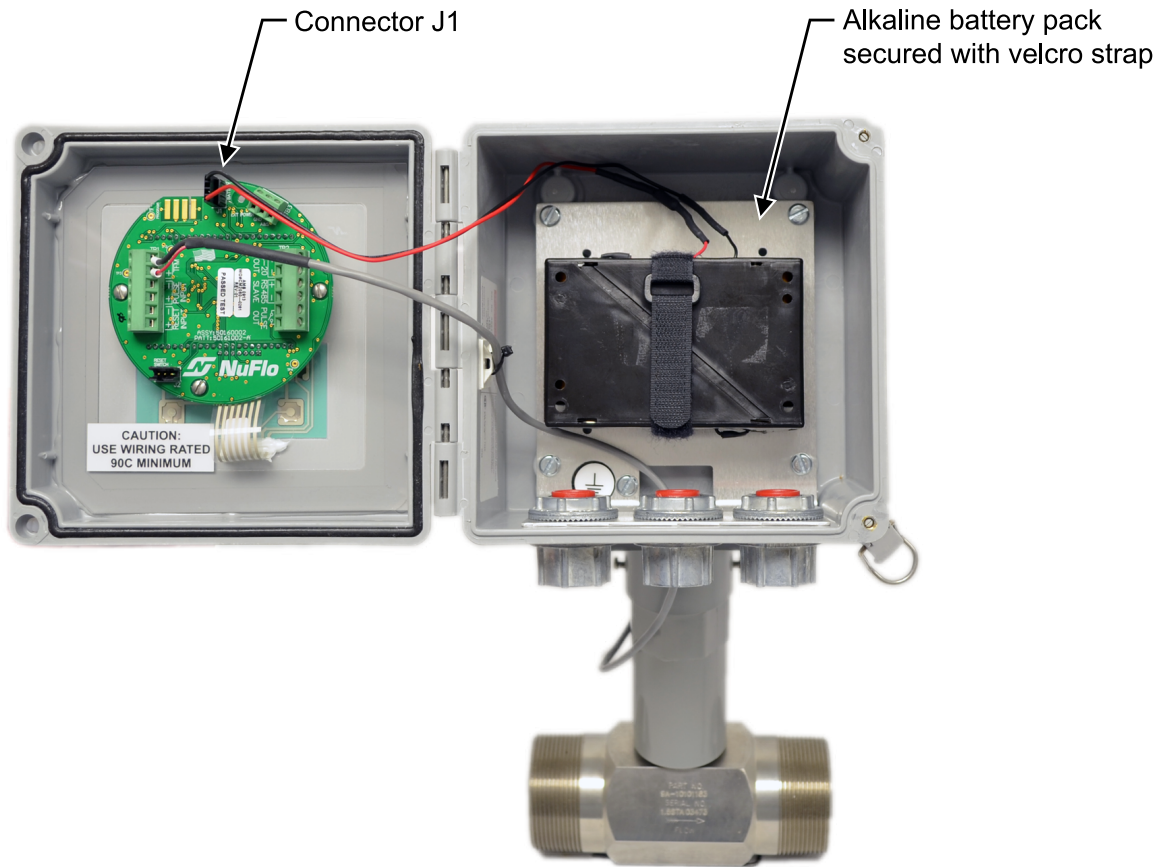

*Figure 6.2—Alkaline battery replacement*

4. Install three new alkaline batteries in the battery holder, observing polarity, position the holder in the enclosure so that the batteries rest against the back plate and secure the velcro strap to hold the batteries tightly in place.
5. Reconnect the battery holder to connector J1 on the circuit assembly.
6. Close the door of the enclosure and secure the latches.

---

**Important:** The interruption of power to the MC-III WP will cause the internal clock time to be inaccurate. Reset the time via the interactive software. See [Time/Date Synchronization](#), page 54.

---

## Circuit Assembly Replacement

**WARNING**

Do not attempt the replacement of the circuit assembly unless the area has been declassified or is known to be non-hazardous.

**Important:** Static electricity can damage a circuit board. Handle new boards only by their edges, and use proper anti-static techniques (such as wearing anti-static wrist strap or touching metal to establish an earth ground) prior to handling a board.

**Important:** If possible, record the accumulated total and all configuration settings before replacing the circuit board. This information can be recorded by hand or captured by saving a configuration file that can be reloaded into the unit after the circuit board is replaced. (See [Saving and Uploading Configuration Files](#), page 71.)

To replace the circuit assembly, perform the following steps:

1. Open the door of the enclosure to access the circuit board mounted inside the door.
2. Record the locations of all cable connections to the circuit assembly.
3. Using a small standard blade screwdriver, remove all wiring from terminal blocks TB1, TB2, and TB3, ensuring that all wiring that is connected to powered circuits is insulated with tape.
4. Unplug the battery cable from connector J1 on the circuit assembly.
5. Using a small Phillips screwdriver, remove the three screws from the circuit assembly (Figure 6.3).

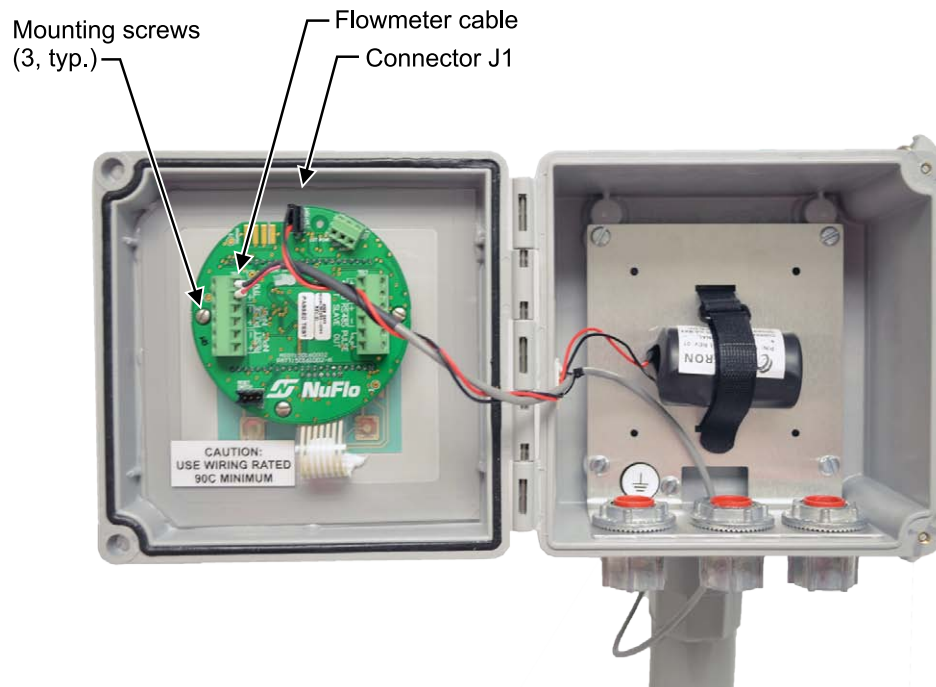

Figure 6.3—Removal of circuit assembly

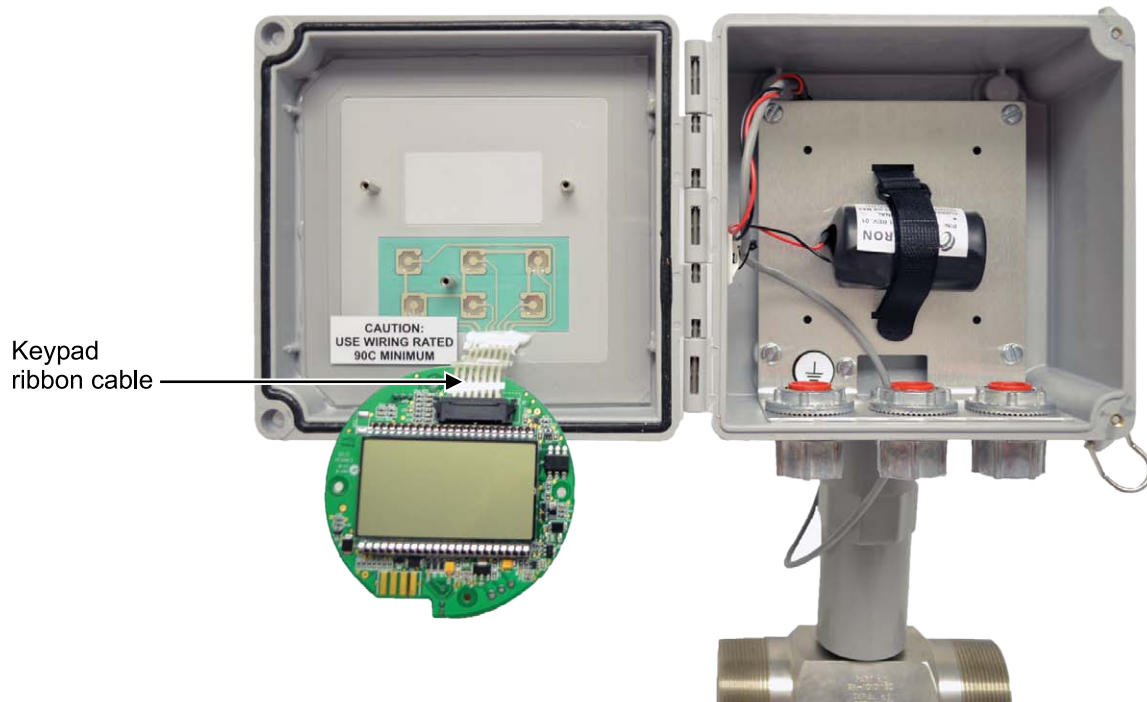

Figure 6.4—Keypad ribbon cable connection

6. Vertically flip the circuit board over to view the opposite side of the board where the LCD is mounted. The keypad ribbon cable will remain attached to the circuit board (Figure 6.4).
7. From the LCD side of the circuit assembly, disconnect the keypad ribbon cable from connector J3 as follows:
  - a. Grasp the black clip between a thumb and forefinger (see white arrows in [Figure 6.5, page 94](#)).
  - b. Squeeze both sides of the clip and gently pull to release the clip from the plastic connector that holds it in place. DO NOT PULL on the ribbon cable. When the black plastic clip is properly disengaged, the cable will release freely.
8. Remove the original circuit assembly from the enclosure.
9. Remove the new circuit assembly from any packaging and connect the ribbon cable of the keypad to connector J3 on the LCD side of the circuit assembly as follows:
  - a. Insert the end of the ribbon cable into the plastic clip.
  - b. While holding the ribbon cable in place, press the black plastic clip into the connector until it snaps.
10. Reconnect the battery cable to connector J1 on the circuit assembly.
11. Center the circuit assembly over the three standoffs on the inside of the enclosure door and secure with the three screws removed in step 5.
12. Reconnect all wiring to terminal blocks TB1, TB2 and TB3.

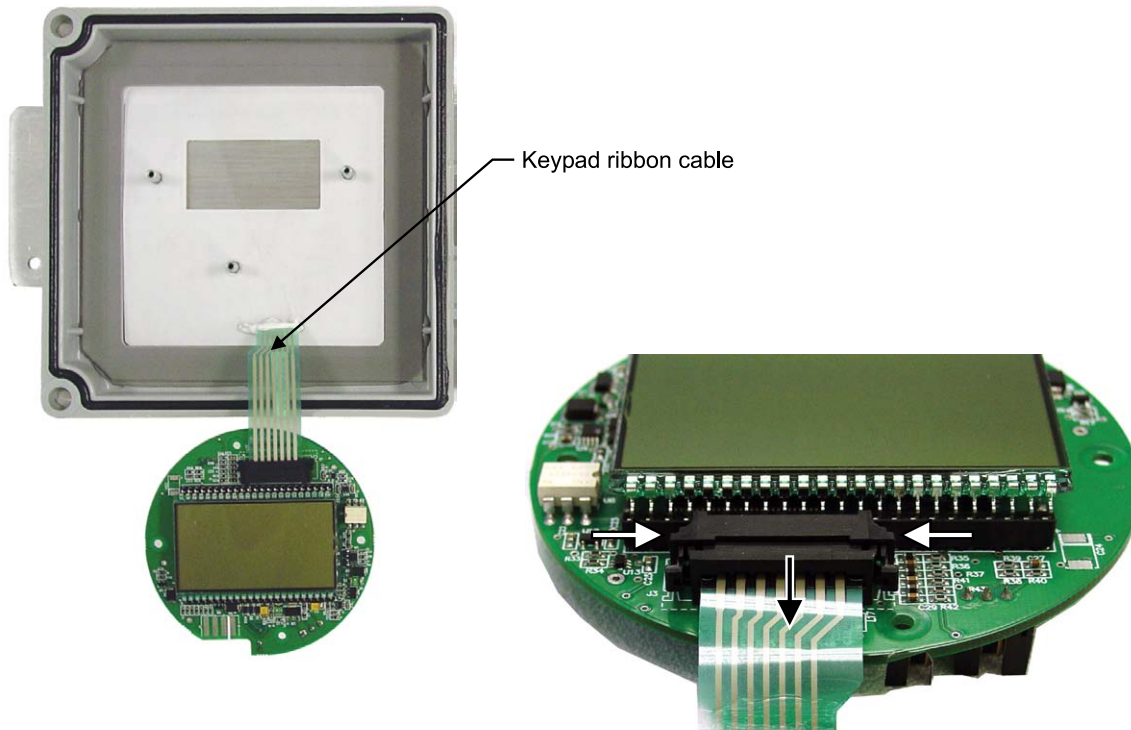

Figure 6.5—To release the ribbon cable from the connector, press in on the side tabs of the connector (white arrows) and gently pull forward (black arrow).

13. Close the door and secure the latches on the enclosure.
14. Recalibrate the MC-III WP.
15. Restore power to the peripheral circuitry.

## Keypad Replacement

### WARNING



**Do not attempt the replacement of the keypad unless the area has been declassified or is known to be non-hazardous.**

The keypad is attached to the circuit board by a ribbon cable that passes from the keypad through a slot in the door and plugs into the LCD side of the circuit board. A silicone rubber sealant is applied to the slot to prevent leakage. Replacement of the keypad requires the operator to remove the old keypad and remove the sealant before installing the new keypad.

To replace the keypad assembly, perform the following steps:

1. Using a small Phillips screwdriver, remove the three screws from the circuit assembly (*Figure 6.3, page 92*).
2. Vertically flip the circuit board over to view the opposite side of the board where the LCD is mounted. The keypad ribbon cable will remain attached to the circuit board (*Figure 6.5*).

3. From the LCD side of the circuit assembly, disconnect the keypad ribbon cable from connector J3 as follows:
  - a. Grasp the black clip between a thumb and forefinger (see white arrows in *Figure 6.5, page 94*).
  - b. Squeeze both sides of the clip and gently pull to release the clip from the plastic connector that holds it in place. **DO NOT PULL** on the ribbon cable. When the black plastic clip is properly disengaged, the cable will release freely.
4. With a sharp instrument, remove the sealant from the slot in the door to free the ribbon cable and to provide a clean surface for installing the new keypad.
5. Using a sharp instrument, lift one corner of the keypad and peel it from the front of the enclosure. Discard the keypad and the attached ribbon cable.
6. Clean the viewing window with rubbing alcohol and allow it to dry.
7. Remove the backing paper from the new keypad.
8. Insert the ribbon cable of the new keypad through the slot in the door of the enclosure.
9. Center the keypad in the viewing window of the door and press it into place. Apply light pressure to the entire surface of the keypad to ensure proper adhesion.
10. Apply an electronic-grade sealant (Dow Corning 738 electrical sealant or equivalent) to the slot around the ribbon cable to prevent leakage. Allow it to dry.

---

**Caution:**     **Never use an acetic acid-based adhesive to seal the ribbon cable slot. Gases released by such products can damage electronics.**

---

11. Connect the keypad ribbon cable to connector J3 on the LCD side of the circuit assembly as follows:
  - a. Insert the end of the ribbon cable into the plastic clip.
  - b. While holding the ribbon cable in place, press the black plastic clip into the connector until it snaps.
12. Reconnect the circuit assembly to the standoffs inside the door using the three screws that were removed from the circuit board in step 1.
13. Close the door and secure the latches on the enclosure.

## Firmware Update

WARNING



**Do not attempt the installation of new firmware unless the area has been declassified or is known to be non-hazardous.**

---

Before installing new firmware or moving the instrument to a new site, it is recommended that the user clear the EEPROM, which will erase all configuration settings and log data. To clear the EEPROM, choose Options/Program Options from the menu bar, select Advanced from the dropdown options list, and click on the “Clear EEPROM” button (*Figure 6.6, page 96*).

Technical assistance is typically required for upgrading firmware. Contact Cameron’s Measurement Systems Division to arrange for an upgrade.

WARNING



Clicking the “Clear EEPROM” button will delete all configuration settings and log records in the MC-III WP memory.

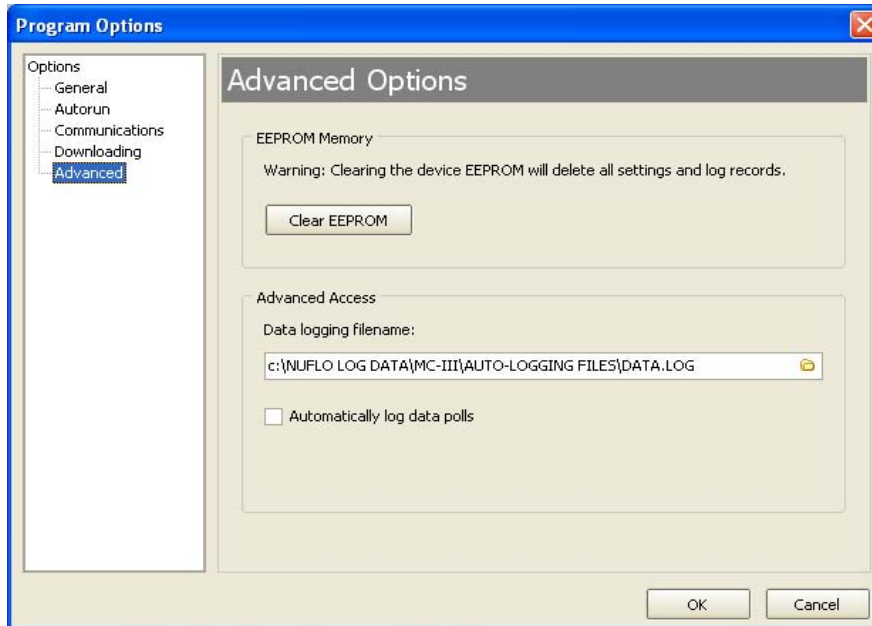

Figure 6.6—EEPROM clearing and automatic data log option

## Spare Parts List

WARNING



**EXPLOSION HAZARD—SUBSTITUTION OF COMPONENTS AND/OR THE USE OF EQUIPMENT IN A MANNER OTHER THAN THAT SPECIFIED BY CAMERON MAY IMPAIR SUITABILITY FOR CLASS I, DIVISION 2. CAMERON BEARS NO LEGAL RESPONSIBILITY FOR THE PERFORMANCE OF A PRODUCT THAT HAS BEEN SERVICED OR REPAIRED WITH PARTS THAT ARE NOT AUTHORIZED BY CAMERON.**

**DO NOT DISCONNECT EQUIPMENT UNLESS POWER HAS BEEN SWITCHED OFF OR AREA IS KNOWN TO BE NON-HAZARDOUS.**

**DO NOT OPEN EQUIPMENT UNLESS SIGNAL CIRCUITS AND POWER HAVE BEEN SWITCHED OFF OR AREA IS KNOWN TO BE NON-HAZARDOUS.**

**BATTERIES MUST ONLY BE CHANGED IN AN AREA KNOWN TO BE NON-HAZARDOUS.**

**STATIC HAZARD. DO NOT CLEAN OR RUB ENCLOSURE UNLESS AREA IS KNOWN TO BE NON-HAZARDOUS.**

Quantity	Part Number	Description
1	9A-50160002	Circuit Assembly
1	9A-90017003	Cable Assembly, MC Series Totalizers, 2-pin Molded Connector, Direct-Mount, 28-in.
1	9A-100005117	Cable Assembly, Flowmeter, Remote-Mount, 10-ft, with Weatherproof Adapter
1	9A-100005111	Battery - Lithium, 3.6 V
1	9A-50099003	Battery Holder, with 3 Alkaline "D" Batteries
1	9A-100002605	Desiccant Packet
1	9A-50074001	Assembly, Installation Software CD and CD Pocket Folder
1	9A-50165009	Manual, User, MC-III WP
1	9A-50165010	Manual, Quick-Start, MC-III WP
2	9A-50006000	Bracket, Direct-Mount, MC-III WP
1	9A-99011007	Strap, Battery, Velcro, 5/8 in. x 14.5 in.
1	9A-50166004	Assembly, Switchplate, MC-III WP

## Optional Parts List

Quantity	Part Number	Description
1	9A-101283116	Converter, RS-485 to RS-232, 9-Pin, with 10-ft Cable
1	9A-100025195	Converter, RS-485 to RS-232, 25-Pin
1	9A-0112-9015T	Converter, RS-485 to RS-232, Serial Port Powered, DB9 Connector on Both Ends
1	2296650-01	Converter, RS-485 to USB, with 20-ft Cable

## Recommended Magnetic Pickups

Quantity	Part Number	Description
1	2295367-01	Pickup, Magnetic, for use with NuFlo liquid turbine meters 3/4" or smaller, -67°F to 225°F (-55°C to 107°C)
1	9A-100002077	Pickup, Magnetic, for use with NuFlo liquid turbine meters 7/8" or larger, -67°F to 250°F (-55°C to 121°C)
1	9A-100002076	Pickup, Magnetic, for use with NuFlo liquid turbine meters 7/8" or larger, -67°F to 450°F (-55°C to 232°C)
1	9A-100003518	Pickup, Magnetic, for use with NuFlo 2" gas turbine meters, 0°F to 225°F (-18°C to 107°C)





## Appendix A—Software Program Options

In addition to the standard configuration and flow log menus, the MC-III™ interface software includes a Program Options menu that allows users to customize the way the software functions, handles log data, and communicates.

To access the Program Options menu, select Options in the menu bar; Program Options is the last entry in the dropdown list (Figure A.1).



Figure A.1—Program Options menu location

### General Options

The General Options screen allows a user to change the threshold setting used to generate a user prompt for synchronizing the internal clock with the time displayed on the user's computer.

The MC-III WP includes a real-time clock for timekeeping and log time stamps, and the internal time and date is preset at the factory. However, if the factory-set time and date are inaccurate for the user (for example, if the user is in a different time zone), the program will automatically detect the difference between the device's internal time and the date and the time/date displayed on the user's personal computer and prompt the user to authorize time and date synchronization.

By default, the MC-III WP prompts a user to synchronize the clock display if the time difference is 60 seconds or more. To change the time difference required to generate a "synchronize" prompt, enter a new threshold value (seconds) in the General Options screen (Figure A.2, page A-2) and click "OK."

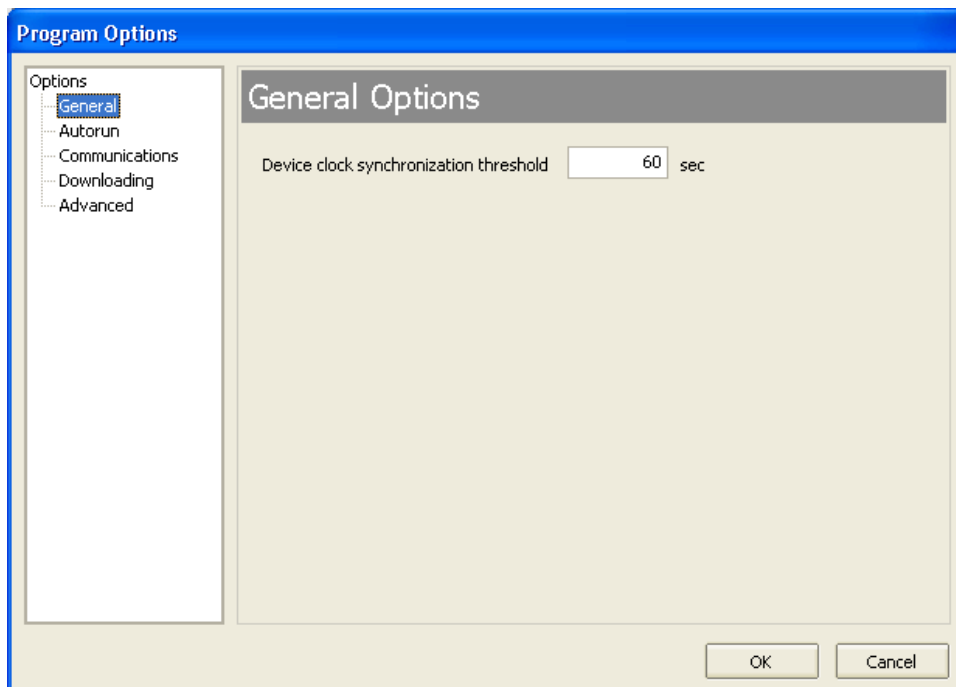

Figure A.2—Threshold setting for internal clock synchronization

## Autorun Options

When the software connects with the MC-III WP, the Device Autorun Options screen appears, prompting the user to select any of six actions, including navigating to one of three configuration screens, downloading flow and event logs, and uploading a configuration file. A checkbox at the bottom of the screen allows the user to automate the selected function each time the software connects to the instrument.

The Autorun Options screen in the Program Options menu (Figure A.3) allows a user to terminate all autorun functions, or change the autorun selection.

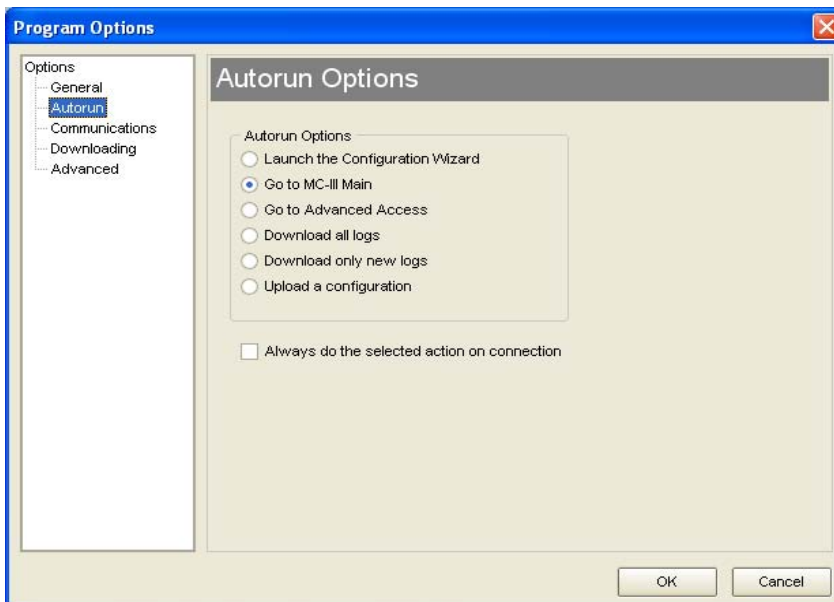

Figure A.3—Menu for changing autorun option selection

To change an autorun setting—that is, to initiate an autorun action, to terminate an autorun action, or to change to a different autorun action at the next connection—select Autorun from the Program Options menu (Figure A.3, page A-2), select the appropriate checkboxes, and click “OK.” Verify that the “Always do...” checkbox is checked if the selected function is to be automated upon each software connection.

## Communications Options

The Communications Options screen (Figure A.4) allows users to customize communication parameters for optimizing performance, depending on the communication path.

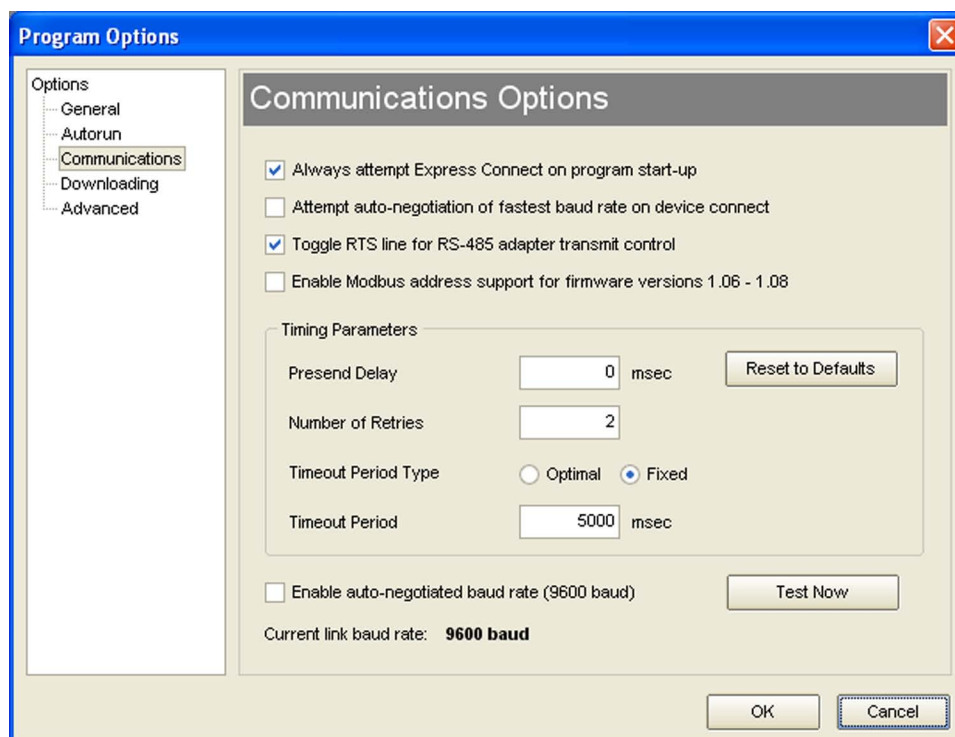

Figure A.4—Menu for changing communication parameters

### Express Connect Option

By default, the interface software automatically attempts to connect to the instrument when a user clicks on the desktop application icon. This feature is controlled by the “Always attempt Express Connect on program startup” checkbox setting in the Communications Option screen (Figure A.4).

When multiple devices are daisy-chained together in a network, the “express connect” function can interfere with the user’s ability to connect to a specific device. To disable the Express Connect function, deselect the “Always attempt...” checkbox and click “OK.” The software will now attempt to connect with the instrument only when the user clicks on the LCD image on the Welcome screen or selects File>Express Connect. For more information, see [Software Connection in Multi-Device Network](#), page 43.

To cancel the “express connect” function without disabling the autorun option, the user can toggle between connect/disconnect by clicking in the LCD area of the device on the Welcome screen.

## Auto-Negotiate Option

When connected devices are capable of switching baud rates automatically or when devices are directly connected to an MC-III WP, a user may configure the MC-III interface to automatically negotiate the fastest baud rate during device connection. This “negotiated” baud rate does not replace the configured baud rate, but rather provides a temporary boost of baud rate while the computer is connected to the device for faster downloads. After the software disconnects, the device reverts to the configured baud rate.

By default, this function is disabled. To enable automatic baud rate negotiation on device connect, check the “Attempt auto-negotiation...” check box in the Communications Option screen (*Figure A.4*, page A-3) and click “OK”. To initiate an immediate search for the fastest baud rate without exiting to the Welcome screen, check the “Enable auto-negotiated baud rate” checkbox, click the “Test Now” button to the right of the checkbox, and click “Yes” at the prompt in the Confirm dialog box.

## Enable Auto-Negotiated Baud Rate Option

The “Enable auto-negotiated...” checkbox enables usage of the baud rate that has been automatically selected or “negotiated” by the software, either upon connection with the instrument or when the “Test Now” button was last clicked. See also *Auto-Negotiate Option* above.

## Request-to-Send (RTS) Line Option

Some RS-485 to RS-232 converter modules require a request-to-send (RTS) line for switching between a “receive” and “transmit” state. This checkbox allows the software to toggle this line, ensuring that incoming data will be readily transmitted and that the converter will not stall in a “receive” mode after a period of inactivity. By default, this option is enabled. To disable the option, deselect the checkbox and click “OK.”

## Enable Modbus Address Support for Firmware Versions 1.06 through 1.08

Operators with MC-III units programmed with firmware versions 1.06 through 1.08 must check the checkbox labeled “Enable Modbus Address Support for Firmware Versions 1.06 through 1.08” to ensure seamless Modbus communication with their units. Operators using any other firmware version with the MC-III should leave the checkbox unchecked.

## Timing Parameters

### *Presend Delay*

On the Communications Options screen, a user can enter a presend delay (milliseconds) to help ensure a successful connection between the computer and the MC-III when the instrument is networked with a radio or other low-speed device. The computer transmits a request to send, which turns the device on, and then waits the specified length of time before attempting to transmit data. By default, this parameter is set to zero.

### *Number of Retries*

By default, the computer will make two attempts to connect to the MC-III WP before providing an error message. In situations where timeouts are anticipated—for example, due to a slow-speed computer—the user can increase the length of time allowed for a connection by inputting a larger number in the Number of Retries field.

### *Timeout Period Type*

A user can select an “optimal” timeout, which is based on the response time of the MC-III WP to various requests for data at all baud rates during extensive testing, or a fixed timeout determined by the user. By default, the “optimal” period type is enabled. When a communication error occurs, the “optimal” timeout allows the software to respond much faster than the more conservative fixed timeout. The optimal setting is recommended when the software is connecting directly to the instrument. The fixed timeout type is

recommended when data is being transmitted through a radio or other network device (serial to TCP/IP) and there are recognizable delays in the communication system.

### **Timeout Period**

When a fixed timeout period type is selected, the user enters the timeout period value (in milliseconds) in the Timeout Period field. When an “optimal” timeout period type is selected, the user can use this field to enter a percentage by which the “optimal” timeout period is extended. This extension can be advantageous when connecting to a slow computer.

## **Downloading Options**

The MC-III WP automatically saves daily flow logs on the contract hour, and hourly flow logs around the clock. The instrument also automatically saves an event log each time a user change is made. By default, the logs are saved as .csv files.

The Downloading Options screen allows a user to change the format of the auto-save flow logs and event logs to Excel (.xls) files. To save the logs in .xls format, check the “XLS-MS Excel File” checkbox (Figure A.5). Additional checkboxes allow for changes in the appearance of downloaded log data.

Users can also export flow data to a .csv or .xls file as needed. For complete information, see [Exporting Flow Logs](#), page 83.

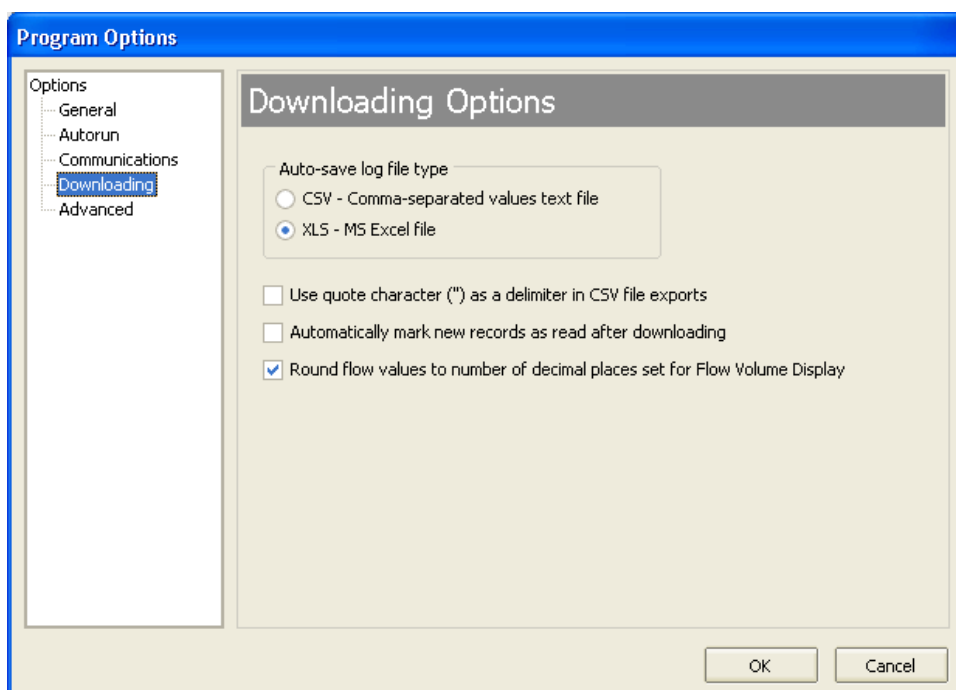

Figure A.5—Menu for changing the auto-save log file format

## Advanced Options

### Clear EEPROM

The Clear EEPROM function will erase all configuration settings and log data. This task is typically performed when updating to a new firmware version or before moving the instrument to a new site. To clear the memory, click on the “Clear EEPROM” button (Figure A.6).

Technical assistance is typically required for upgrading firmware. Contact Cameron’s Measurement Systems Division to arrange for an upgrade.

**WARNING**

Clicking the “Clear EEPROM” button will delete all configuration settings and log records in the MC-III WP memory.

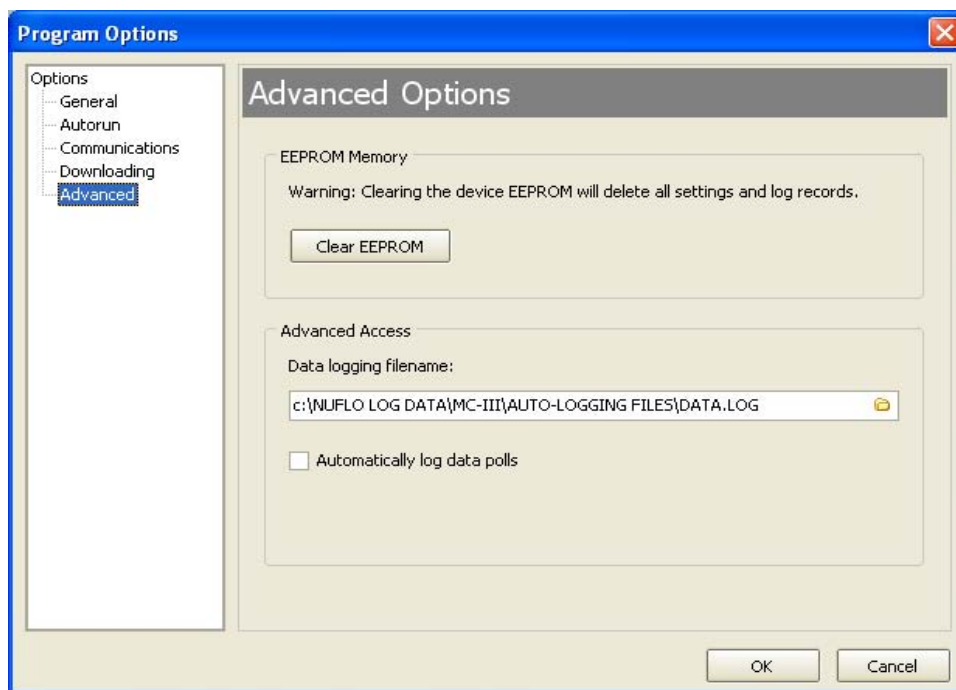

Figure A.6—Menu for clearing EEPROMs and enabling automatic data logs

### Automatic Data Logging

Data retrieved from the MC-III WP while in Advanced access mode can be logged to a file by enabling the “Automatically log data polls” checkbox on the Advanced Options screen. To specify the filename and location of the file, click the folder icon on the right of the Data logging filename field. The file will include values that are retrieved from the instrument when the user clicks the “Get All Data” button or enables “Auto Polling” on the Advanced Access screen. See also [Advanced Access](#), page 74.

## Appendix B—Lithium Battery Information

### Lithium Battery Disposal

Once a lithium battery is removed from a device and/or is destined for disposal, it is classified as solid waste under EPA guidelines. Depleted lithium batteries are also considered to be hazardous waste because they meet the definition of Reactivity, as per 40 CFR 261.23(a)(2), (3) and (5). This document describes how the lithium reacts violently with water, forms potentially explosive mixtures with water, and when exposed to certain pH conditions, generates toxic cyanide or sulfide gases.

Federal law requires that depleted lithium batteries be sent to a fully permitted Treatment, Storage and Disposal Facility (TSDF) or to a permitted recycling/reclamation facility.

---

**Important:** Do not ship lithium batteries to Cameron. Cameron facilities are not permitted recycling/reclamation facilities.

---

---

**Caution:** Profiling and waste characterization procedures must be followed prior to shipping a lithium battery to a disposal site. It is the shipper's responsibility to comply with all applicable federal transportation regulations (see below).

---

### Transportation Information

---

**Warning:** The MC-III WP™ Flow Analyzer contains lithium batteries. The internal component (thionyl chloride) is hazardous under the criteria of the Federal OSHA Hazard Communication Standard 29 CFR 1920.1200. Before shipping a lithium battery or equipment containing a lithium battery, verify that the packaging and labeling conforms with the latest version of all applicable regulations.

---

The transport of the lithium batteries is regulated by the United Nations, “Model Regulations on Transport of Dangerous Goods,” (special provisions 188, 230, and 310), latest revision.

Within the US the lithium batteries and cells are subject to shipping requirements under Part 49 of the Code of Federal Regulations (49 CFR, Parts 171, 172, 173, and 175) of the US Hazardous Materials Regulations (HMR), latest revision.

Shipping of lithium batteries in aircraft is regulated by the International Civil Aviation Organization (ICAO) and the International Air Transport Association (IATA) requirements in Special Provisions A45, A88 and A99, latest revision.

Shipping of lithium batteries on sea is regulated the International Maritime Dangerous Goods (IMDG) requirements in special provisions 188, 230 and 310, latest revision.

Shipping of lithium batteries on road and rail is regulated by requirements in special provisions 188, 230 and 310, latest revision.

### Material Safety Data Sheet

For a link to the current MSDS for the lithium batteries used to power the MC-III WP Flow Analyzer, see the Cameron website: [www.c-a-m.com/flo](http://www.c-a-m.com/flo).





## Appendix C—Communications Protocol

### Firmware Version 2.03 Register Table Version 1

### Introduction

The communications protocol for the MC-III is in accordance with Modicon, Inc. RTU Mode Modbus® as described in *Modicon Modbus Protocol Reference Guide*, PI-MBUS-300 Rev. J, June 1996. All registers are implemented as 4X or holding registers. Reading of registers is implemented via function code 03H (Read Holding Registers). Writing to registers is implemented via function code 10H (Preset Multiple Registers). The instrument provides Enron Modbus® compliant downloads for hourly, daily and event records. For details on Enron Modbus®, refer to *Specifications and Requirements for an Electronic Flow Measurement Remote Terminal Unit for Enron Corp.*, Dec. 5, 1994.

### Supported Commands

The Modbus® functions supported by the MC-III are as follows:

Function Code (Hex)	Description
03	Read Holding Registers
05	Preset Boolean (for Enron event record acknowledgement)
10	Preset Multiple Registers

For the read holding and preset multiple registers, the instrument supports the full 250 bytes of data in a message. This corresponds to 125 registers in 16-bit holding register size and 62 registers in 32-bit holding register size.

### Data Types

Various data types are implemented in the MC-III. The following table lists the formats and the numbers of bytes and registers associated with each type.

Data Type	Byte Count	Register Count
Floating Point (FP)	4	2
Floating Point (FP32)	4	1
Unsigned Word (U16)	2	1
Packed ASCII (PA)	2	1

The Floating Point (FP) type follows the IEEE-754 format and consists of 32 bits contained in two registers. It is utilized for parameters and values that are not integers. For example, Instantaneous Flow Rate is a parameter that is a floating-point data type. It can be interpreted by reading two registers, starting with register 17014.

The Floating Point-32 bit (FP32) data type follows the IEEE-754 format and consists of 32 bits contained in a single register.

The standard word ordering for multiple register data types, such as floating-point numbers or long integers, is for the most significant word to appear first in the message. For master devices requiring the least significant word to appear last, a subset of registers is provided on [page C-11](#).

The Unsigned Word (U16) type is used for 16-bit integers and fits into one register.

The Packed ASCII (PA) type contains two bytes that are two unsigned characters. Generally, multiple Packed ASCII types are arranged consecutively for implementing strings. For example, the device's well name is a string of 10 unsigned characters that is implemented as 5 Packed ASCII registers. Here is an example of a well name that contains the string, "Test Well 413."

Register	Hexadecimal #	ASCII Characters
210	54 65	Te
211	73 74	St
212	20 57	<SPACE>W
213	65 6C	eI
214	6C 20	I<SPACE>
215	34 31	41
216	33 FF	3<UNUSED>

Unused characters at the end of each string will report 0xFF hexadecimal.

## Registers

Each register has an Access type: read-only or read-write, as described below.

Access Type	Description
Read Only (RO)	Register can only be read.
Read/Write (R/W)	Register can be read and written.

The registers are grouped into Modbus® map blocks based on function. The MC-III contains the following map functions.

Function	Starting Register
System Configuration	1000
Real Time	1200
Input Configuration	2000
Output Configuration	4000
Holding Register (16-bit)	8000 and 17001
Holding Register (32-bit)	7000
Control Registers	70
Wellsite Parameters	200

Note All registers cited in this document refer to the address of the register that appears in the actual Modbus® message. For example, register 17001 has an address of 0x4268 Hexadecimal in the message.

Note Two sets of 16-bit holding registers are provided (starting at 17001 and 8000). The “8000” set should be used with master devices that require the holding registers to be in the range of 40000 to 49999.

### System Configuration

Register (Decimal)	Register (Hex)	Description	Data Type	Access	Default
1000	03E8	Product Code	U16	RO	64
1001	03E9	Register Table Version Number	U16	RO	1
1002	03E	Firmware Version Number (Version = register value divided by 100) (Example: 100 = Version 1.00)	U16	RO	
1003	03EB	Manufacture Date (MMYY)	U16	RO	
1004	03EC	Sales Date (MMYY)	U16	RO	
1005	03ED	Serial Number 1	U16	RO	
1006	03EE	Serial Number 2	U16	RO	
1007	03EF	Power Mode 0 = High Power 1 = Low Power	U16	R/W	1
1008	03F0	Internal System Sample Rate Number of seconds to measure temperature and battery voltage	U16	R/W	3600
1009	03F1	Slave Address [1-65535, not including 252-255 or 64764]	U16	R/W	1
1010	03F2	Baud Rate <i>Low Power</i> <i>High Power</i> 0 - 300                    5 - 9600 1 - 600                    6 - 19200 2 - 1200                  7 - 38400 3 - 2400                  8 - 57600 4 - 4800                  10 - 115200 5 - 9600	U16	R/W	5
1011	03F3	Bus Delay – mS of delay before transmitting data (Delay = register value multiplied by 10 mS)	U16	R/W	1 (10 ms)
1012	03F4	Bus Timeout – mS of delay before resetting Modbus® (Timeout = register value multiplied by 10 mS)	U16	R/W	5 (50 mS)
1013	03F5	Contract Hour [0-23]	U16	R/W	8
1014	03F6	Lock Code [0001-9999]	U16	R/W	0

### System Configuration

Register (Decimal)	Register (Hex)	Description	Data Type	Access	Default
1015	03F7	Lock Code Enable 0 - Disabled 1 - Enabled	U16	R/W	0
1016	03F8	LCD Contrast [0-31]	U16	R/W	6

#### Product Code (register 1000)

The Product Code is a read-only parameter used for identification. This parameter is set at the factory and it will always read 0x40 hexadecimal (64 decimal).

#### Firmware/Register Table Version Numbers (registers 1001, 1002)

The Firmware Version and Register Table Version numbers are unsigned 16-bit integers. These parameters are set at the factory and are read-only. To determine the firmware version number, read the appropriate register and divide the value read by 100. The general format for firmware version numbers is A.BC. For example, the firmware register number is read as 0xA7 hexadecimal. This represents 167 and a firmware version of 1.67.

#### Manufacture Date/Sales Date (registers 1003, 1004)

These parameters are set at the factory and are read-only. These registers are formatted as MMY. For example, a value of 0905 represents the date September 2005.

#### Slave Address (register 1009)

The Modbus® slave address is an unsigned word (U16) data type that has a range of values from 1 to 65535, not including 252 through 255 or 64764. The slave address is configured from a laptop or via the keypad and is stored in nonvolatile memory.

---

**Important** All MC-III devices will respond to addresses 252 through 255 and 64764, and the response will always be at a baud rate of 9600 baud. For this reason, addresses 252 through 255 and 64764 are reserved and should never be used.

---

When the slave address is written, the response message will be at the current address. After the response message is transmitted, the MC-III will change to the new slave address.

#### Baud Rate (register 1010)

The baud rate is an unsigned word (U16) data type that sets the data rate on the serial port. When the baud rate is written, the response message will be at the current baud rate. After the response message is transmitted, the MC-III will change to the new baud rate.

### Real Time

Register (Decimal)	Register (Hex)	Description	Data Type	Access
1200	04B0	Year (Real Year = register value plus 2000)	U16	R/W
1201	04B1	Month [1-12]	U16	R/W
1202	04B2	Day [1-31]	U16	R/W

1203	04B3	Hour [0-23]	U16	R/W
1204	04B4	Minute [0-59]	U16	R/W
1205	04B5	Second [0-59]	U16	R/W

This block of registers is used to set the instrument's internal clock. To set the time, it is recommended that all registers be written in one message.

The time and date can also be read in the holding register groups as floating-point data.

### ***Input Configuration***

Register (Decimal)	Register (Hex)	Description	Data Type	Access	Default
2000	07D0	Volume Units  <i>Units</i> <i>Units × 1000</i> 0 = No Units              16 = No Units 1 = Gallons                17 = Gallons 2 = Barrels                18 = Barrels 3 = Cubic Meters        19 = Cubic Meters 4 = Cubic Feet            20 = Cubic Feet 5 = Liters                 21 = Liters  <i>Standard Units</i> <i>Std. Units × 1000</i> 32 = No Units            48 = No Units 33 = Gallons              49 = Gallons 34 = Barrels              50 = Barrels 35 = Cubic Meters      51 = Cubic Meters 36 = Cubic Feet         52 = Cubic Feet 37 = Liters                53 = Liters	U16	R/W	2
2001	07D1	Volume Decimal Point Location 1 = Tenths 2 = Hundredths 3 = Thousandths 4 = Ten Thousandths	U16	R/W	1

**Input Configuration**

Register (Decimal)	Register (Hex)	Description	Data Type	Access	Default
2002	07D2	Rate Volume Units <i>Units</i> <i>Units × 1000</i> 0 = No Units                16 = No Units 1 = Gallons                 17 = Gallons 2 = Barrels                 18 = Barrels 3 = Cubic Meters         19 = Cubic Meters 4 = Cubic Feet             20 = Cubic Feet 5 = Liters                    21 = Liters  <i>Standard Units</i> <i>Std. Units × 1000</i> 32 = No Units              48 = No Units 33 = Gallons               49 = Gallons 34 = Barrels               50 = Barrels 35 = Cubic Meters        51 = Cubic Meters 36 = Cubic Feet           52 = Cubic Feet 37 = Liters                 53 = Liters	U16	R/W	2
2003	07D3	Rate Time Base 0 = Second 1 = Minute 2 = Hour 3 = Day	U16	R/W	3
2004	07D4	Rate Decimal Point Location 0 = No digits to the right of the decimal point 1 = Tenths 2 = Hundredths 3 = Thousandths	U16	R/W	2
2005	07D5	Calculation Period (sec)	U16	R/W	4
2006	07D6	Turbine Meter Input Configuration 0 = Pulse Input 1 = TFM - LOW 2 = TFM - MED 3 = TFM - HIGH	U16	R/W	1
2007	07D7	Low Frequency Cut-Off Threshold (Hz)	U16		2
2008	07D8	Factor Type 1 = 1-Point K-Factor 2 = 2-Point K-Factor ... 12 = 12-Point K-Factor	U16	R/W	1

**Input Configuration**

Register (Decimal)	Register (Hex)	Description	Data Type	Access	Default
2009	07D9	Factor Units 0 = No Units 1 = Gallons 2 = Liters 3 = Barrels 4 = Cubic Feet 5 = Cubic Meters	U16	R/W	1
2010	07DA	Factor Decimal Point Location 0 = No digits to the right of the decimal point 1 = Tenths 2 = Hundredths 3 = Thousandths 4 = Ten Thousandths	U16	R/W	2
2011	07DB	Calibration Frequency [1] (Hz)*	FP	R/W	1.00
2013	07DD	Calibration Frequency [2] (Hz)*	FP	R/W	1.00
2015	07DF	Calibration Frequency [3] (Hz)*	FP	R/W	1.00
2017	07E1	Calibration Frequency [4] (Hz)*	FP	R/W	1.00
2019	07E3	Calibration Frequency [5] (Hz)*	FP	R/W	1.00
2021	07E5	Calibration Frequency [6] (Hz)*	FP	R/W	1.00
2023	07E7	Calibration Frequency [7] (Hz)*	FP	R/W	1.00
2025	07E9	Calibration Frequency [8] (Hz)*	FP	R/W	1.00
2027	07EB	Calibration Frequency [9] (Hz)*	FP	R/W	1.00
2029	07ED	Calibration Frequency [10] (Hz)*	FP	R/W	1.00
2031	07EF	Calibration Frequency [11] (Hz)*	FP	R/W	1.00
2033	07F1	Calibration Frequency [12] (Hz)*	FP	R/W	1.00
2035	07F3	Calibration Factor [1]* (pulses per configured factor unit)	FP	R/W	900.00
2037	07F5	Calibration Factor [2]* (pulses per configured factor unit)	FP	R/W	1.00
2039	07F7	Calibration Factor [3]* (pulses per configured factor unit)	FP	R/W	1.00
2041	07F9	Calibration Factor [4]* (pulses per configured factor unit)	FP	R/W	1.00
2043	07FB	Calibration Factor [5]* (pulses per configured factor unit)	FP	R/W	1.00
2045	07FD	Calibration Factor [6]* (pulses per configured factor unit)	FP	R/W	1.00
2047	07FF	Calibration Factor [7]* (pulses per configured factor unit)	FP	R/W	1.00
2049	0801	Calibration Factor [8]* (pulses per configured factor unit)	FP	R/W	1.00

### **Input Configuration**

Register (Decimal)	Register (Hex)	Description	Data Type	Access	Default
2051	0803	Calibration Factor [9]* (pulses per configured factor unit)	FP	R/W	1.00
2053	0805	Calibration Factor [10]* (pulses per configured factor unit)	FP	R/W	1.00
2055	0807	Calibration Factor [11]* (pulses per configured factor unit)	FP	R/W	1.00
2057	0809	Calibration Factor [12]* (pulses per configured factor unit)	FP	R/W	1.00
2059	080B	Standard Measurement Correction Factor (to be configured by software only)	FP	RO	1.00
2061	080D	Low Flow Rate Cut-Off Threshold (in terms of configured flow rate units)	FP	R/W	1.00

\*Calibration frequencies and calibration factors are associated in pairs—i.e., Calibration Frequency [1] and Calibration Factor [1]— and must be sorted in ascending order, based on calibration frequency values, prior to writing the values to the instrument. Therefore, Calibration Frequency [1] should be the smallest of all calibration frequencies.

### **Output Configuration**

Register (Decimal)	Register (Hex)	Description	Data Type	Access	Default
4000	0FA0	Pulse Output Source 0 = Test Mode/Disabled 1 = Enabled	U16	R/W	0
4001	0FA1	Pulse Output Duration (time is register value multiplied by 10 ms)	U16	R/W	10 (100 mS)
4002	0FA2	Pulse Output Decimal Point Location	U16	R/W	2
4003	0FA3	Pulse Output Scale Factor (in terms of configured volume units)	FP	R/W	1.00
4005	0FA5	Analog Output Source 0 = Test Mode/Disabled 1 = Enabled	U16	R/W	0
4006	0FA6	Analog Output Decimal Point Location	U16	R/W	2
4007	0FA7	Analog Output Low Value (in terms of configured flow rate units)	FP	R/W	0.00
4009	0FA9	Analog Output High Value (in terms of configured flow rate units)	FP	R/W	1700.00

---

**Important** Two sets of 16-bit holding registers are provided (starting at 17001 and 8000). The “8000” set displayed in parentheses in the table on page C-9 should be used with master devices that require the holding registers to be in the range of 40000 to 49999.

---



**Holding Registers (16-bit Mode)**

Register (Decimal)	Register (Hex)	Description	Data Type	Access
17001 (8000)	4269 (1F40)	Hourly Pointer [1 to 768]	FP	RO
17003 (8002)	426B (1F42)	Daily Pointer [1 to 384]	FP	RO
17005 (8004)	426D (1F44)	Event Counter [1 to 345]	FP	RO
17007 (8006)	426F (1F46)	Real Date (MM/DD/YY)	FP	RO
17009 (8008)	4271 (1F48)	Real Time (HH:MM:SS)	FP	RO
17011 (8010)	4273 (1F4A)	Grand Total (in terms of configured volume units)	FP	RO
17013 (8012)	4275 (1F4C)	Instantaneous Flow Rate (in terms of configured flow rate units)	FP	RO
17015 (8014)	4277 (1F4E)	Daily Total (in terms of configured volume units)	FP	RO
17017 (8016)	4279 (1F50)	Daily Run Time (seconds)	FP	RO
17019 (8018)	427B (1F52)	Hourly Total (in terms of configured volume units)	FP	RO
17021 (8020)	427D (1F54)	Hourly Run Time (seconds)	FP	RO
17023 (8022)	427F (1F56)	Polling Total (in terms of configured volume units)	FP	RO
17025 (8024)	4281 (1F58)	Polling Run Time (seconds)	FP	RO
17027 (8026)	4283 (1F5A)	Previous Day Total (in terms of configured volume units)	FP	RO
17029 (8028)	4285 (1F5C)	Previous Day Run Time (seconds)	FP	RO
17031 (8030)	4287 (1F5E)	Previous Hour Total (in terms of configured volume units)	FP	RO
17033 (8032)	4289 (1F60)	Previous Hour Run Time (seconds)	FP	RO
17035 (8034)	428B (1F62)	Previous Polling Total (in terms of configured volume units)	FP	RO
17037 (8036)	428D (1F64)	Previous Polling Run Time (seconds)	FP	RO
17039 (8038)	428F (1F66)	Polling Index [0-65535]	FP	RO
17041 (8040)	4291 (1F68)	Internal Temperature (°C)	FP	RO

**Holding Registers (16-bit Mode)**

Register (Decimal)	Register (Hex)	Description	Data Type	Access
17043 (8042)	4293 (1F6A)	Supply Voltage (VDC)	FP	RO
17045 (8044)	4295 (1F6C)	Battery Voltage (VDC)	FP	RO
17047 (8046)	4297 (1F6E)	Grand Total (base unit)	FP	RO
17049 (8048)	4299 (1F70)	Instantaneous Flow Rate (base unit)	FP	RO
17051 (8050)	429B (1F72)	Daily Total (base unit)	FP	RO
17053 (8052)	429D (1F74)	Daily Run Time (seconds)	FP	RO
17055 (8054)	429F (1F76)	Hourly Total (base unit)	FP	RO
17057 (8056)	42A1 (1F78)	Hourly Run Time (seconds)	FP	RO
17059 (8058)	42A3 (1F7A)	Polling Total (base unit)	FP	RO
17061 (8060)	42A5 (1F7C)	Polling Run Time (seconds)	FP	RO
17063 (8062)	42A7 (1F7E)	Previous Day (base unit)	FP	RO
17065 (8064)	42A9 (1F80)	Previous Day Run Time (seconds)	FP	RO
17067 (8066)	42AB (1F82)	Previous Hour (base unit)	FP	RO
17069 (8068)	42AD (1F84)	Previous Hour Run Time (seconds)	FP	RO
17071 (8070)	42AF (1F86)	Previous Polling Total (base unit)	FP	RO
17073 (8072)	42B1 (1F88)	Previous Polling Run Time (seconds)	FP	RO
17075 (8074)	42B3 (1F8A)	Polling Index [0-65535]	FP	RO
17077 (8076)	42B5 (1F8C)	Pulse Output Pulses	FP	R/W
17079 (8078)	42B7 (1F8E)	Analog Output Current	FP	R/W
17081 (8080)	42B9 (1F90)	Calculated K-Factor (in terms of configured factor unit)	FP	R/W

Note: The registers below should be used with master devices that require the floating point numbers to be presented with the least significant word first. Their counterparts with floating point numbers in reverse word order—registers 17011, 17013, 17027 and 17015—are listed in the previous table.

### ***Holding Registers (16-bit Mode)—Least Significant Word First***

Register (Decimal)	Register (Hex)	Description	Data Type	Access
550	226	Grand Total (in terms of configured volume units)	FP	RO
552	228	Instantaneous Flow Rate (in terms of configured flow rate units)	FP	RO
554	22A	Daily Total (in terms of configured volume units)	FP	RO
556	22C	Previous Day Total (in terms of configured volume units)	FP	RO

### **Base Units/Configured Units**

The holding register area provides two blocks of registers. The first block is based on the *configured* units of measurement. The configured volume units will follow the settings in the Volume Unit register (2000). The configured rate units will follow the settings in the Rate Volume units (2002) and the Time-Base register (2003).

For example, if the settings for the volume unit is 2 (BBL), all of the total parameters such as Grand Total (17011), Daily Total (17015), etc. will be in terms of barrels. The values in these registers will change if the user changes the units of measurement that appear on the LCD.

The second block is in terms of *base* units. These register values are independent of the configured volume units in the Volume Unit, Rate Volume Unit, and Time-Base registers. For base units, the time base is always measured in seconds, and the volume and rate volume units are measured in gallons. If the standard correction factor has been enabled, the volume unit is standard gallons. The standard gallon is calculated as the gallon measurement times the Standard Measurement Correction factor (2059). If the x1000 unit is enabled, the volume unit is gallons times 1000.

### **Conversion Factors**

For base units, the volume unit and rate volume unit is measured in gallons. To convert gallons to another unit of measure, use the conversion factors listed in the table below. For example, to convert gallons to barrels, multiply gallons times 0.02380952381.

To Convert From Gallons To...	Multiply By...
No units	1.0000000000
Barrels	0.02380952381
Cubic meters	0.00378541178
Cubic feet	0.13368055556
Liters	3.78541178400

## Polling Registers

The MC-III device stores the volume accumulated since the last polling sequence in a set of polling registers (17023). In addition, the instrument monitors the number of seconds of flow time in each polling interval (17025). There is also an index to the number of polls requested (17039).

The polling sequence is started by writing to the Control Register. Writing the Control Register 1 (70) with a value of 20000 decimal transfers the polling total (17023) and polling run time (17025), to the previous polling total (17035) and previous polling run time (17037) registers, increments the polling index (17039) register and resets the polling total and polling run time registers.

## Pointer/Daily/Event Pointer (registers 17001 through 17006)

These registers provide an index of the last record that was stored in the log data. These values start at 1 and increment with each newly created log. When the maximum number of records is reached, the pointer resets at 1 and starts incrementing again.

## Real Date (registers 17007, 17008)

This register is a floating-point representation of the date, formatted as MMDDYY. For example, a value of 91005 represents a date of September 10, 2005.

## Real Time (registers 17009, 17010)

This register is a floating-point representation of time, formatted as HH:MM:SS. For example, a value of 180205 represents a time of 6:02:05 PM.

## Totals

The instrument provides Grand Total (17011), Daily Total (17015), Hourly Total (17019) and a Polling Total (17023). It also provides Previous Day Total (17027), Previous Hour Total (17031), and Previous Polling Total (17035). These totals are available in terms of configured units and base units. Refer to [Base Units/Configured Units](#), page C-11, for details.

## Pulse Output Pulses (register 17077)

When the pulse output is enabled (see Pulse Output Source, register 4000), this register indicates the current number of output pulses to be sent to the output relay, based on the configured duration. In a typical application, this register will generally indicate a small number, then quickly count down to zero. In a situation where pulses are being cached, the pulses register will indicate a large value. When the pulse output is disabled, a user can use this register to write a desired number of pulses to be output, for use in testing end devices. Users can also perform this output test from the software Pulse Output configuration screen. For details, see [Pulse Output Testing](#), page 70.

## Analog Output Current (register 17079)

When the analog output is enabled (see Analog Output Source, register 4005), this register indicates the calculated output current based on the low and high values and the instantaneous flow rate. When the analog output is disabled, a user can use this register to write a desired output current for use in testing end devices. Users can also perform this output test from the software 4-20 mA Output configuration screen. For details, see [4-20 mA Output Testing](#), page 67.

## Calculated K-Factor (register 17081)

This register represents the K-factor that was used for the most recent calculation interval. This number is calculated based on the factor type (register 2008), the instantaneous frequency from the flowmeter,

calibration frequencies (registers 2011 through 2033), and calibration factors (registers 2035 through 2057). The unit of measurement for this register is pulses per configured factor unit. Once the K-factor is calculated based on frequency and K-factor points, this value is multiplied by 1000 if the user chooses to read the volume in units x 1000, and it is divided by the Standard Measurement Correction Factor (register 2059).

### ***Holding Registers (32-bit Mode)***

Register (Decimal)	Register (Hex)	Description	Data Type	Access
7000	1B58	Hourly Pointer [1 to 768]	FP32	RO
7001	1B59	Daily Pointer [1 to 384]	FP32	RO
7002	1B5A	Event Counter [1 to 345]	FP32	RO
7003	1B5B	Real Date (MM/DD/YY)	FP32	RO
7004	1B5C	Real Time (HH:MM:SS)	FP32	RO
7005	1B5D	Grand Total (in terms of configured volume units)	FP32	RO
7006	1B5E	Instantaneous Flow Rate (in terms of configured flow rate units)	FP32	RO
7007	1B5F	Daily Total (in terms of configured volume units)	FP32	RO
7008	1B60	Daily Run Time (seconds)	FP32	RO
7009	1B61	Hourly Total (in terms of configured volume units)	FP32	RO
7010	1B62	Hourly Run Time (seconds)	FP32	RO
7011	1B63	Polling Total (in terms of configured volume units)	FP32	RO
7012	1B64	Polling Run Time (seconds)	FP32	RO
7013	1B65	Previous Day Total (in terms of configured volume units)	FP32	RO
7014	1B66	Previous Day Run Time (seconds)	FP32	RO
7015	1B67	Previous Hour Total (in terms of configured volume units)	FP32	RO
7016	1B68	Previous Hour Run Time (seconds)	FP32	RO
7017	1B69	Previous Polling Total (in terms of configured volume units)	FP32	RO
7018	1B6A	Previous Polling Run Time (seconds)	FP32	RO

**Holding Registers (32-bit Mode)**

Register (Decimal)	Register (Hex)	Description	Data Type	Access
7019	1B6B	Polling Index [0-65535]	FP32	RO
7020	1B6C	Internal Temp (°C)	FP32	RO
7021	1B6D	Supply Voltage (VDC)	FP32	RO
7022	1B6E	Battery Voltage (VDC)	FP32	RO
7023	1B6F	Grand Total (base unit)	FP32	RO
7024	1B70	Instantaneous Flow Rate (base unit)	FP32	RO
7025	1B71	Daily Total (base unit)	FP32	RO
7026	1B72	Daily Run Time (seconds)	FP32	RO
7027	1B73	Hourly Total (base unit)	FP32	RO
7028	1B74	Hourly Run Time (seconds)	FP32	RO
7029	1B75	Polling Total (base unit)	FP32	RO
7030	1B76	Polling Run Time (seconds)	FP32	RO
7031	1B77	Previous Day (base unit)	FP32	RO
7032	1B78	Previous Day Run Time (seconds)	FP32	RO
7033	1B79	Previous Hour (base unit)	FP32	RO
7034	1B7A	Previous Hour Run Time (seconds)	FP32	RO
7035	1B7B	Previous Polling Total (base unit)	FP32	RO
7036	1B7C	Previous Polling Run Time (seconds)	FP32	RO
7037	1B7D	Polling Index [0-65535]	FP32	RO
7038	1B7E	Pulse Output Pulses	FP32	R/W
7039	1B7F	Analog Output Current	FP32	R/W
7040	1B80	Calculated K-Factor (in terms of configured factor unit)	FP32	RO

### Control Register

Register (Decimal)	Register (Hex)	Description	Data Type	Access
70	0046	Control Register #1	U16	R/W

The Control register allows specific functions to be implemented via the communication port. The following table shows the value to be written to the control register to implement the desired function.

Code	Function
20000	Transfers the polling total and polling run time to the previous polling total and previous polling run time registers, increments the polling index register, and resets the polling total and polling run time registers.
30000	Resets grand total
40000	Loads factory defaults
40040	Creates processor reset

### Wellsite Parameters

Register (Decimal)	Register (Hex)	Description	Data Type	Access
200	00C8	Company Name [20 characters]	PA	RO
210	00D2	Well Name [20 characters]	PA	RO
220	00DC	Site Location [20 characters]	PA	RO
300	012C	Site ID [20 characters]	PA	RO
310	0136	Tag Name [10 characters]	PA	RO
315	013B	Legal Description [34 characters]	PA	RO
400	0190	Sensor Model Number [20 characters]	PA	RO
410	019A	Sensor Serial Number [20 characters]	PA	RO
420	01A4	Measurement Type [20 characters]	PA	RO
500	01F4	User Note [64 characters]	PA	RO

These registers provide access to the ASCII characters that are used in the Wellsite Information screen of the software. These registers are read-only; if these parameters need to be changed, the user must use the interface software program.

### Log Data

The MC-III provides Enron Modbus® compliant downloads. For detailed instructions on downloading hourly, daily and event data, refer to *Specifications and Requirements for an Electronic Flow Measurement Remote Terminal Unit for Enron Corp.* If an Enron host is not available or is too cumbersome to implement, the Enron records are individually addressed in another Modbus® map. Contact Cameron technical support for details.

The following registers are used for hourly, daily and event log registers. Hourly and daily records comprise five values (registers). See the [Hourly/Daily Record Format table](#). Note that event records are downloaded one at a time.

### **Enron Registers**

Register (Decimal)	Register (Hex)	Description	Data Type	Access
32	0020	Enron Modbus® Event Log Register	Refer to Enron Event Record Format	RO
700	02BC	Enron Modbus® Hourly Log	Refer to Enron Hourly/Daily Record Format	RO
701	02BD	Enron Modbus® Daily Log	Refer to Enron Hourly/Daily Record Format	RO
7000	1B58	Hourly Pointer [1 to 768]	FP32	RO
7001	1B59	Daily Pointer [1 to 384]	FP32	RO
7002	1B5A	Event Counter [1 to 345]	FP32	RO

### **Enron Hourly/Daily Record Format**

Parameter	Data Type
Date (MMDDYY)	FP32
Time (HH:MM:SS)	FP32
Total (base units)	FP32
Flow Time (number of seconds of flow)	FP32
Supply Voltage (VDC)	FP32



**Enron Event Record Format**

Parameter	Data Type
Status	U16
Address	U16
Time (HH:MM:SS)	FP32
Date (MMDDYY)	FP32
As-Found	FP32
As-Left	FP32

The Event Log status is a 16-bit value used to indicate the reset source in the event log. The following table indicates the reset status.

**Reset Status**

Status Code	Value
Normal	0
Power-On Reset	3
Watch-Dog	8
Software Reset	16
Flash Memory Error	32

**Log Capacity**

Log Type	Capacity
Hourly Logs	768
Daily Logs	384
Event Logs	345



WARRANTY - LIMITATION OF LIABILITY: Seller warrants only title to the products, software, supplies and materials and that, except as to software, the same are free from defects in workmanship and materials for a period of one (1) year from the date of delivery. Seller does not warranty that software is free from error or that software will run in an uninterrupted fashion. Seller provides all software "as is". THERE ARE NO WARRANTIES, EXPRESS OR IMPLIED, OF MERCHANTABILITY, FITNESS OR OTHERWISE WHICH EXTEND BEYOND THOSE STATED IN THE IMMEDIATELY PRECEDING SENTENCE. Seller's liability and Buyer's exclusive remedy in any case of action (whether in contract, tort, breach of warranty or otherwise) arising out of the sale or use of any products, software, supplies, or materials is expressly limited to the replacement of such products, software, supplies, or materials on their return to Seller or, at Seller's option, to the allowance to the customer of credit for the cost of such items. In no event shall Seller be liable for special, incidental, indirect, punitive or consequential damages. Seller does not warrant in any way products, software, supplies and materials not manufactured by Seller, and such will be sold only with the warranties that are given by the manufacturer thereof. Seller will pass only through to its purchaser of such items the warranty granted to it by the manufacturer.

MEASUREMENT SYSTEMS

HOUSTON  
HEAD OFFICE

**281.582.9500**

NORTH  
AMERICA

**1.800.654.3760**

ms-us@c-a-m.com

ASIA  
PACIFIC

**+603.2287.1039**

ms-asiapacific@c-a-m.com

EUROPE,  
MIDDLE EAST  
& AFRICA

**+44.1243.826741**

ms-uk@c-a-m.com

USA • CANADA • UK • SCOTLAND • CHINA • UAE • ALGERIA • MALAYSIA • INDIA • KENYA • [www.c-a-m.com/flo](http://www.c-a-m.com/flo)

